

# ZOOM

## Technical Specifications



A stand alone sit stand desk which offers easy to control settings, perfect for a user that is wanting to maximize their small office space.

Zoom has the easiest navigation for a sit-stand desk. With just the touch of a button, the precise two-button panel allows effortless movement of the desk from 685 - 1185mm max in height.

**10 year guarantee.**

## ZOOM Products



**Single Desk**



**Frame**

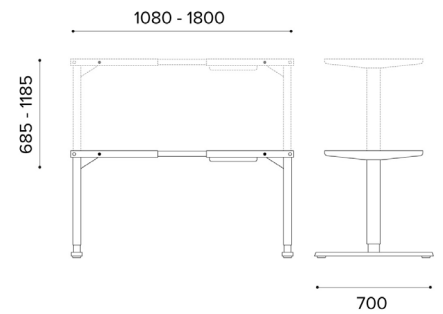

**Dimensions**

## Top Colours:



MAPLE

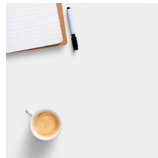

WHITE



GREY

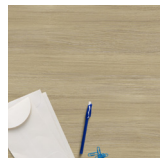

URBAN  
OAK

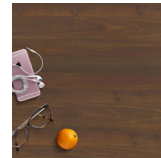

DARK  
WALNUT

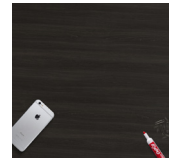

HARBOUR  
OAK

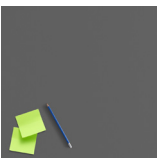

GRAPHITE

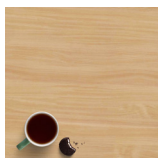

BEECH

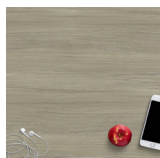

ARCTIC OAK

## Frame Colours:



SILVER

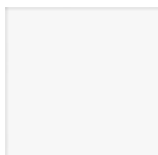

WHITE



BLACK

# ZOOM Options

Available Top Types: Plain, Portals or Dual Scallop

Top depths 700 and 800mm, Top widths 1200, 1400, 1600 and 1800mm.



PLAIN



PORTAL



DUAL SCALLOP

## PLYWOOD EDGING AVAILABLE

Add plywood edging to a Zoom sit stand desk to add an extra design element and set your desk apart.



---

## Technical Specifications

- Height 685 - max 1185mm, stroke: 500mm
- Available in 2 depths of top: 700mm & 800mm
- Frames to fit widths of top: 1200, 1400, 1600, 1800mm
- Speed 40mm/s
- Lifting Power: distributed load - 125kg (frame only)
- Noise < 50 decibels
- Power 220-230V
- Control Box: control unit 2 ports voltage input 220-240 VAC 50/60Hz
- Overheat electrical current protection
- Handset: basic handset, two buttons: rise/fall, black
- Six-axis anti-collision software - prevents any accidents when you, or an item comes into contact with your desk
- Guarantee 10-years

---

## ZOOM Certificates

- Complies with EMC Directive
- Complies with Low Voltage Directive
- Complies with RoHS Directive (Reach and PAHs)
- Zoom desks are WEEE certified (Waste Electrical and Electronic Equipment) meaning that any electrical goods you purchase from us we will recycle for free at the end of their life cycle
- GreenTag Certified