

sedus

Swivel and visitor chairs

crossline prime & crossline





Superior seating culture: Sedus crossline prime.

The experience of sitting in this management armchair is beyond compare: like a shadow, the seat and backrest follow every body movement in absolute harmony. The body is perfectly supported at all times, without being controlled by the technology.

Once you get used to this incomparable comfort, you will never want to settle for anything less! When superlative function looks this elegant, seating culture has truly reached a new high: Sedus *crossline prime*.

Design: Markus Dörner

You've got to show backbone at the top.

At the heart of the Sedus *crossline prime* design is the patented "Similar-Plus" mechanism, which is the epitome of dynamic sitting and promotes relaxed working. The innovative backrest support structure, made of polished aluminium, is visible and makes for a striking design feature. The chromed aluminium armrests with leather finish are both aesthetically pleasing and functional at the same time. With its special lines and high-quality material, the chair exudes safe support, reliable strength and powerful dynamism.









Consistent design throughout the office.

Successful management is based on successful communication. Staff and management meetings and also one-to-one meetings represent much of the managerial workload. The *crossline prime* conference swivel chairs are a valuable contributor. A floating backrest and impact-absorbing bearing underneath the seat ensure that they are both comfortable and relaxing. What's more, with their distinguished looks, they are the perfect match for the *crossline prime* swivel chair.



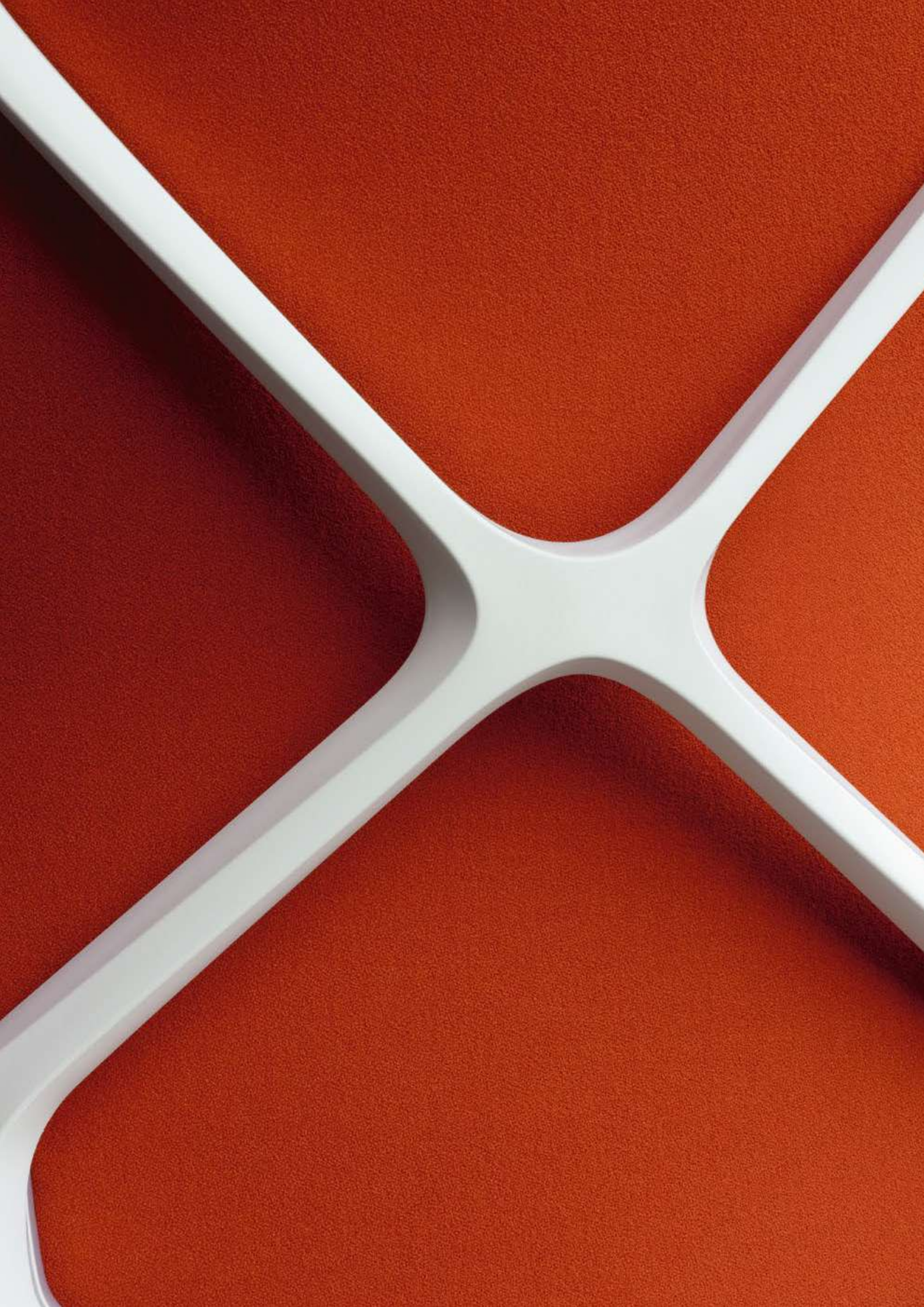

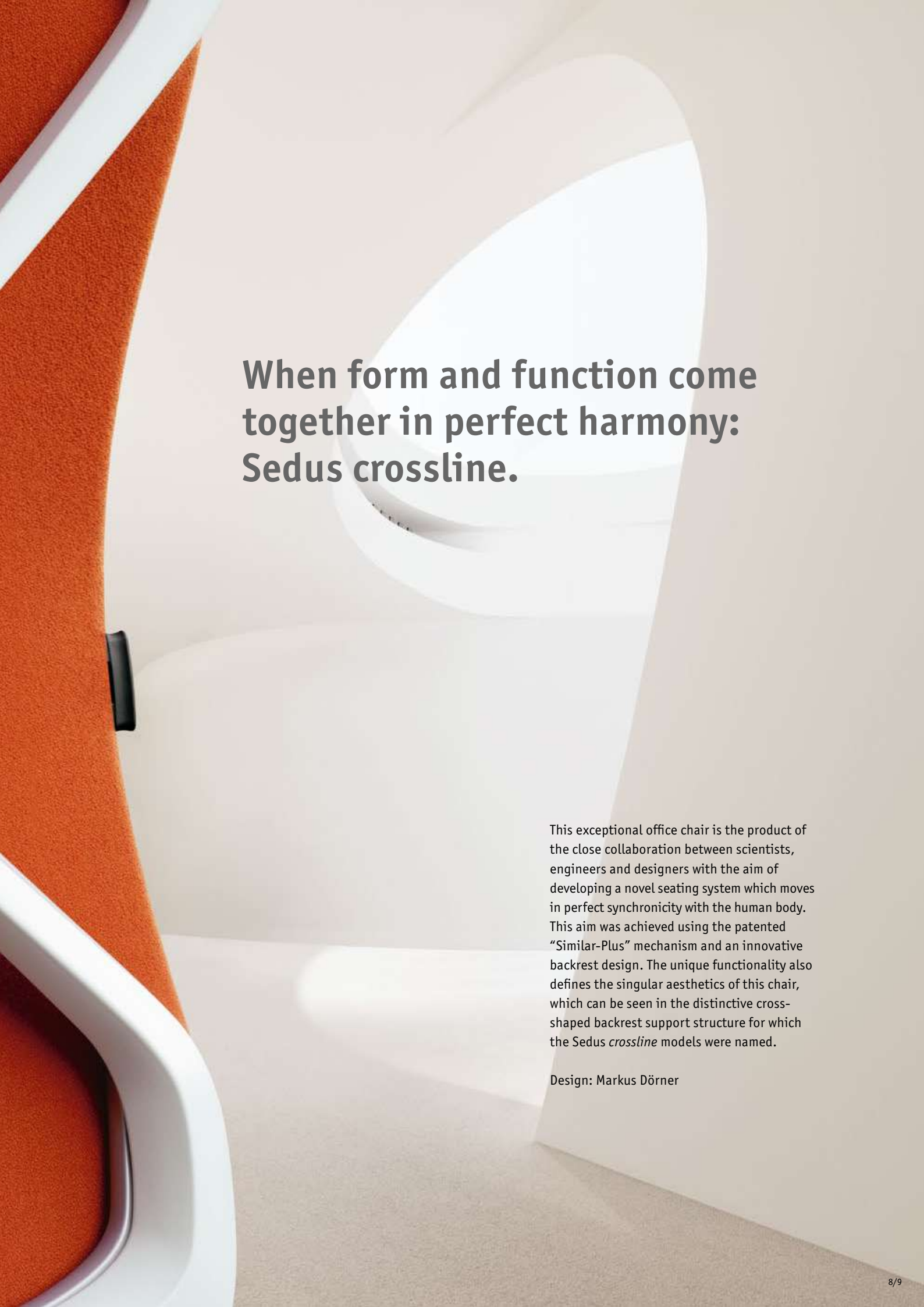

When form and function come together in perfect harmony: Sedus crossline.

This exceptional office chair is the product of the close collaboration between scientists, engineers and designers with the aim of developing a novel seating system which moves in perfect synchronicity with the human body. This aim was achieved using the patented "Similar-Plus" mechanism and an innovative backrest design. The unique functionality also defines the singular aesthetics of this chair, which can be seen in the distinctive cross-shaped backrest support structure for which the Sedus *crossline* models were named.

Design: Markus Dörner



Motivation through appreciation.



People and their ideas are the productive capital which determines the success of a company. This is why perfect sitting ergonomics is not a luxury, but rather a fundamental requirement for employees to be able to perform their best.

Sedus *crossline* is a premium range of office chairs which sets the bar in ergonomics and lets employees know that they and their work are appreciated by their company.

Simply good posture.

The "Similar-Plus" mechanism combined with the individually adjustable opening angle keeps the backrest in constant contact with the back and provides optimal support without taking control.

Headrest. Detachable, made of black leather; for fabric-covered swivel chairs with high backrest on request.



Lumbar support.

Height-adjustable for customisation to the user's lower spine.

Multifunctional arm-rests.

3D adjustable to prevent tension in the shoulder and arm muscles.



Perfect sitting experience. For ease and convenience of adjustment, all of the important operation and control elements are positioned within easy reach, labelled with clear symbols and have a pleasant feel. Each element is designed to be self-explanatory and intuitive. By adjusting the pre-selectable opening angle, the chair can be adapted to suit the particular activity. For still monitor work, for example, the range of movement can be less than for relaxing and leaning back when telephoning, reading or contemplating.

Seat adjustment.

The seat is generously proportioned with soft upholstery; the seat depth is adjustable to provide comfortable seating for all users, whatever their height.

Seat height. Can easily be adjusted by lever to suit the user's height.

Backrest pressure. Can be customised to suit the user's weight in an instant.



Opening angle. Pre-selectable 4-stage adjustment.

Seat tilt. Can be set to different angles.

How to achieve the optimal working posture.

Brainwork is all about mental agility, and to maintain that, physical mobility is called for. Dynamic sitting gets the circulation going and takes the load off the intervertebral discs, neck and back muscles. Perfectly engineered, Sedus *crossline* ensures exceptionally balanced movements, which encourages users to change their sitting position while working.



Comfort. With dynamic sitting, the perfect, smooth-as-silk movement of the “Similar-Plus” mechanism prevent the annoying “shirt-pulling” effect.





Flexible support. The backrest with support structure and the mobile, flexible upholstery support the back in every move. The iliac crest region is perfectly supported in all working positions.

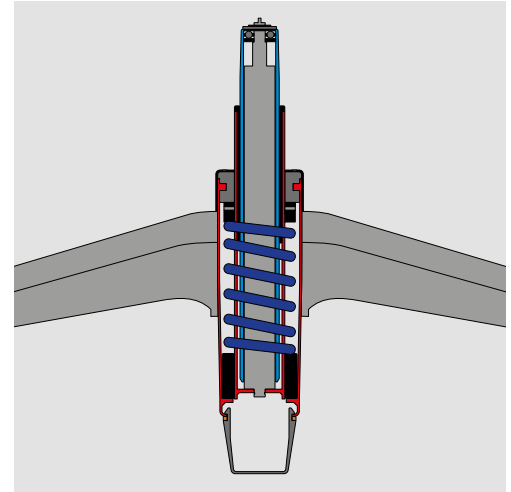

Soft as a feather. Thanks to the patented Sedo Lift mechanism, the seat height adjusts easily and continuously. At the same time, soft, pleasant, back-friendly cushioning is guaranteed regardless of the chosen seat height. However, the Sedo Lift mechanism is not only extremely comfortable, but also non-wearing and thus highly durable.



Individuals as team players.

The knowledge workers in today's networked offices are increasingly rarely all alone at their desks. Fortunately, this does not mean you cannot have the unmistakable aesthetics and

unique sitting experience of a Sedus *crossline*, as Sedus has an extensive range of versatile matching visitor and conference chairs.



Seating culture to suit every corporate culture.

Drab grey is out; today offices are a more striking and creative statement of the corporate culture. The secret to a well-designed office chair is therefore an expressive form, yet one which blends harmoniously into high-end surroundings. The Sedus *crossline* product family offers a variety of material and colour combinations to meet just about every creative wish. All Sedus *crossline* and *crossline prime* models are available with high-quality fabric and leather finishes.



Wide range.

13 leather and 140 fabric colours give almost unlimited creative scope.

Creamy Comfort. A homely style which plays with warm woods and natural colours and creates features by mixing materials in interesting combinations.

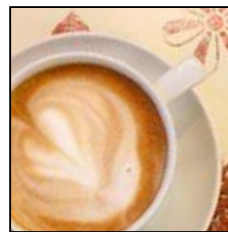

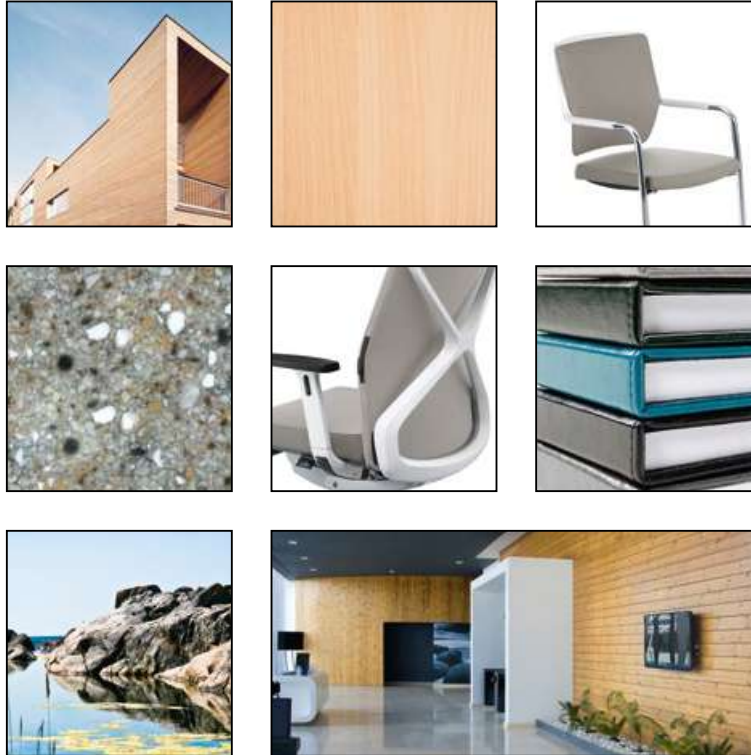

Scandinavian Ease. Natural materials, light colours and modern, sleek forms radiate the lightness of an island summer.

Fresh Asia. Straight lines, clean forms, light materials and reduced colours create an atmosphere of harmony and calmness.



crossline

crossline prime



Swivel chairs with high backrest



Swivel chairs with medium backrest



Conference swivel chairs, either with glides or castors



Cantilever models, optionally stackable

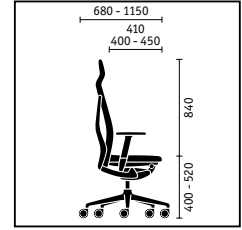
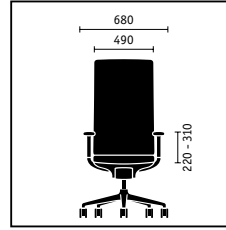

The Sedus crossline range.

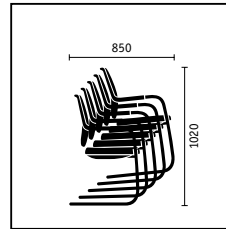
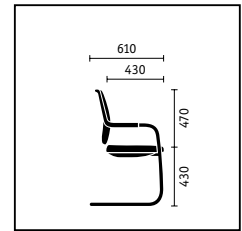
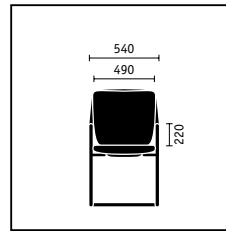
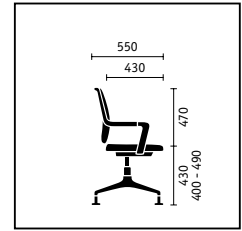
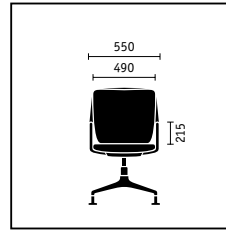
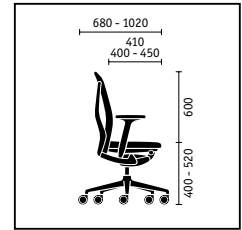
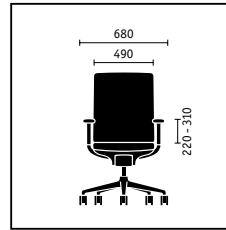

Further information and planning data are available to download at: www.sedus.com

	crossline prime swivel chair	crossline swivel chair	Conference swivel chair	Cantilever
Mechanisms				
"Similar-Plus" mechanism	■	■		
"Similar-Plus" mechanism with seat tilt adjustment of 4°	□	□		
Backrest technical features				
Pre-selectable opening angle (0, 11, 22, 32°)	■	■		
Height-adjustable lumbar support (60 mm)	■	■		
Adjustable backrest pressure	■	■		
Sprung backrest			■	
Seat height adjustment				
"Sedo-Lift" mechanism	■	■		
Gas lift mechanism	□	□		
Central seat-depth springing (not height-adjustable)			■	
Gas lift mechanism with mechanical depth springing			□	
Automatic return (seat height not adjustable)			□	
Base designs				
Aluminium base, powder-coated in black		■	■	
Aluminium base, powder-coated in white aluminium		□	□	
Aluminium base, powder-coated in white		□	□	
Polished aluminium base	■	□	□ *	
Frame versions				
Steel frame, powder-coated in black				■
Steel frame, powder-coated in white aluminium				□
Steel frame, chromed				□
Model colour/plastic parts				
Black	■	■	■	■
White		□	□	□
Armrest versions				
Without armrests		□		
3D adjustable armrests with Softtouch finish		■		
3D adjustable armrests with gel finish		□		
3D adjustable armrests with leather finish		□		
Aluminium armrests with plastic finish			■	
Aluminium armrests with leather finish	■		□	
Steel armrests with plastic finish				■
Steel armrests with leather finish				□ *
Features				
Headrest integrated into the backrest	□	□		
Black leather headrest	□	□		
Different cover for backrest upholstery	□	□	□	□
Sliding seat (50 mm)	□	□		
Hard castors for soft floors	■	■	□	
Soft castors for hard floors	□	□	□	
Plastic glides			■	□
Felt glides			□	□
Stackable (up to 5 high)				□

* Standard with crossline prime

□ optional ■ standard



Company::



Sedus crossline prime & crossline:





Sustainability down to the last detail.

At Sedus, sustainability and quality “Made in Germany” have formed part of our key corporate principles for more than 50 years. Principles which are united in Sedus *crossline* and which are reflected in its recycling-oriented product design, ecologically tested materials, resource-efficient manufacturing demonstrating energy awareness and ongoing quality tests.

For example, instead of a conventional paint finish, a solvent-free powder coating is used on *crossline*. State-of-the-art and extremely environmentally friendly electroplating, in which all production residues containing metal are recycled, is also part of Sedus’ quality and sustainability philosophy.

For further information, visit www.sedus.com

Fabrics which last longer. Exemplary when it comes to tear strength, chemical resistance and light fastness.



Local leather. First-class quality and short transport routes – all the leather we use comes from Southern Germany and Austria.



Powder coating instead of a paint finish. The more environmentally friendly and higher quality solution for finishing and corrosion protection.



Around the world, Sedus adheres to the principles of the UN Global Compact for human rights, labour standards, the environment and anti-corruption.

