

www.actiu.com



000.9095 • 06-13 • 1'



ACTIU TECHNOLOGY PARK
project certified as LEED® GOLD
by U.S. Green Building Council 2011
Leadership in Energy & Environmental Design



POR FAVOR RECICLAR CUANDO QUEDE OBSOLETO
PLEASE RECYCLE WHEN OBSOLETE
S'IL VOUS PLAÎT, MERCI DE RECycler
WENN NICHT MEHR AKTUELL, RECYCELN

SPINE



ACTIU

Spine

Programa diseñado por el dpto. I+D+i de ACTIU - Program designed by ACTIU R & D department - Programme de design du dpt. I+D+i d ACTIU - Dieses Programm wurde von der Forschungs-, Entwicklungs- und Innovationsabteilung von ACTIU entworfen



As a backbone

Actiu presenta **SPINE**, la nueva solución para espacios de trabajo que permite configurar infinitas posibilidades para trabajar de forma individual o en equipo, optimizando el espacio.

Actiu presents **SPINE**, the new solution for workspaces which enables endless configurations to work individually or in a team, optimizing space.

Actiu présente **SPINE**, la nouvelle collection pour les espaces de travail avec un nombre infini de possibilités de configuration aux postes de travail individuel ou en équipe, tout en optimisant l'espace..

Actiu präsentiert **SPINE**, die Neuentwicklung für Arbeitsbereiche mit unendlich vielen Konfigurationsmöglichkeiten und optimaler Raumnutzung für Einzel- oder Gruppenarbeitsplätze



SPINE se articula como una 'espinas dorsal' en la que quedan ancladas las diferentes composiciones que configuran el espacio de trabajo.

SPINE is structured as a 'backbone' in which different compositions are anchored from that to form the workspace.

Spine s'articule comme une «épine dorsale» dans laquelle nous fixons les différentes configurations possible pour créer un espace de travail.

SPINE ist wie ein „Rückgrat“ aufgebaut, an dem man die unterschiedlichen raumgestaltenden Elemente befestigt

Capaz de conseguir la adecuada privacidad en espacio abiertos.

Los usuarios necesitan oficinas comunicadas y espacios abiertos que apoyen el trabajo de colaboración, pero también que proporcionen privacidad.

Capable of achieving adequate privacy in open spaces.

Users need interconnecting offices and open spaces to support collaborative work, but also which provide privacy.

Permet de créer des aires fermées et intimes dans des espaces ouverts.

Les utilisateurs ont besoin de poste de travail qui favorise la synergie et des espaces ouverts pour un travail en collaboration avec une aire de confidentialité.

Eine angemessene Privatmosphäre herstellen – auch in offenen Räumen.

Die Nutzer benötigen kommunikationsfördernde Büros, die sowohl die Zusammenarbeit unterstützen, als auch Privatsphäre bieten.

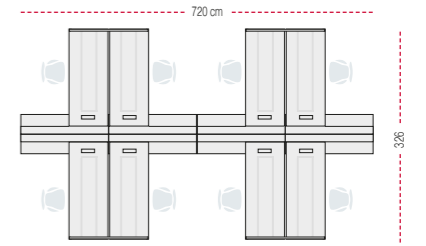

Interconnecting, open and collaborative offices



Mayor rendimiento y distribución del espacio
Higher performance and space distribution

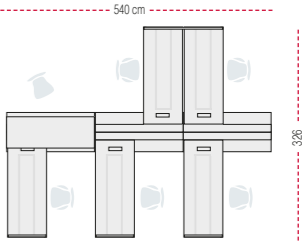

Spine fusiona el espacio con la función, según las necesidades de cada proyecto, permitiendo múltiples composiciones en medidas, acabados y soluciones técnicas.

Spine fuses space with function, according to the needs of each project, enabling multiple size compositions, finishes and technical solutions.

Spine tient en compte les différents aménagements pour permettre aux postes de s'adapter avec des configurations sur mesure, des éléments de finition précis et des solutions techniques.

Spine lässt den Raum mit seiner Funktion verschmelzen, ganz nach den Anforderungen jedes Arbeitsprojekts: Vielfältige Anordnungen, Maße, Oberflächenverarbeitungen und technische Lösungen sind möglich.

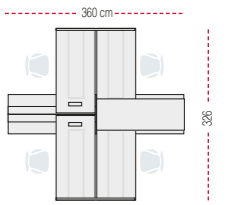



Easy adaptation

AT WORK

Detalle de la gestión de cables
 Detail of cable management
 Gestion du câblage
 Schematische Ansicht der Kabelführung

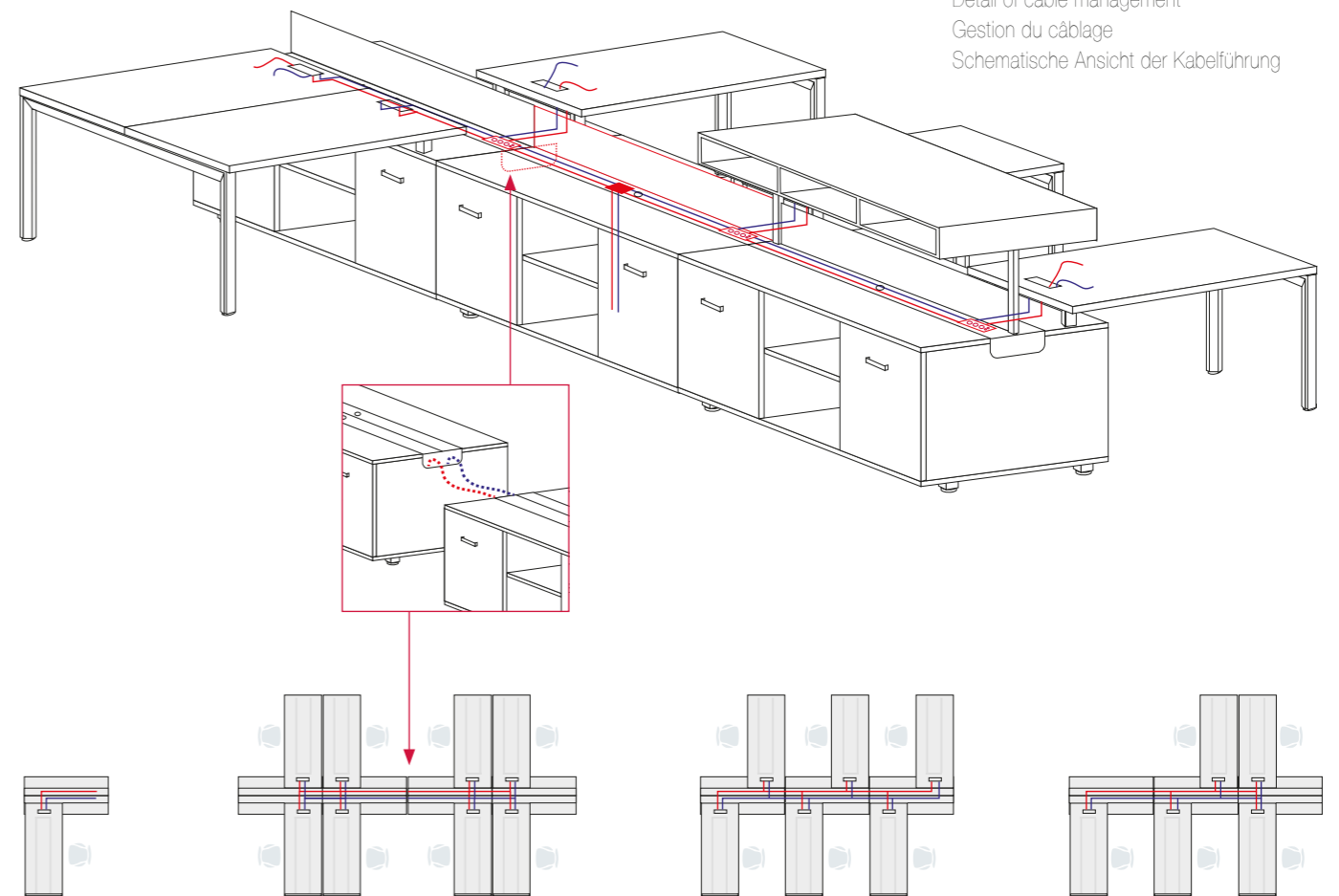

Una solución sobria y elegante, que sintetiza, reduce e integra los elementos.
 La ingeniosa gestión de la electrificación a través del armario, posibilita el cableado de todo el puesto de trabajo en conjunto.

A sober and elegant solution, which synthesizes, reduces and integrates elements.
 The ingenious management of electrification through the cabinet, enables wiring throughout the whole job position altogether.

Une solution sobre et élégante qui synthétise, réduit et intègre les éléments.
 Une solution ingénieuse sur la gestion du câblage à travers l'armoire qui permet un réseau commun pour l'ensemble des postes

Eine funktionelle und elegante Anordnung, hoch integriert und mit einer minimalen Anzahl an Bestandteilen.
 Eine ausgeklügelte Führung der Stromkabel durch die Schrankelemente ermöglicht die gemeinsame Verkabelung aller Arbeitsplätze.

Armarios modulares de diferentes alturas y tipos de conexión, en combinación con mesas, terceros planos de trabajo, elementos organizadores y divisorias para un apantallamiento acústico y visual, posibilitan una diversidad de soluciones.

Modular cabinets of different heights and types of connection, in combination with desks, third work surfaces, organizing elements and dividers to provide an acoustic and visual screen, enabling a variety of solutions.

Les armoires basses modulaires de différentes hauteurs et de dispositif de connexion avec les tables fonctionnelles, les plans de travail, les éléments de rangements, les panneaux écrans à isolation phonique et visuel, nous permettent un infini de solution.

Schrankmodule unterschiedlicher Höhe lassen sich mit Tischen, Anschlüssen verschiedener Art, dritten Arbeitsebenen und Organisationselementen kombinieren. Dabei sorgen Raumteiler für akustische und visuelle Abschirmung und trennen die Räume nach Belieben.

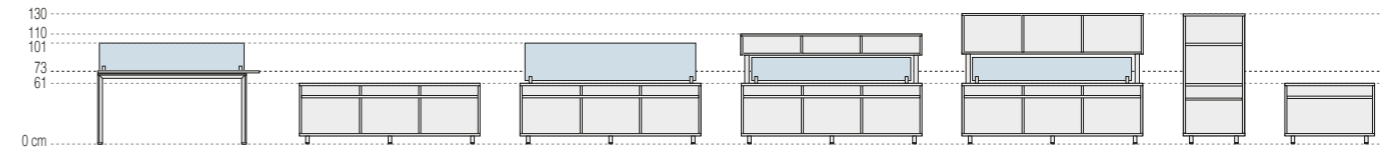

Technical Features

- 1 - El archivo central soporta los accesorios y canaliza el cableado.
- 2 - Módulos de almacenaje con puertas deslizantes, cajones, librerías abiertas y soluciones mixtas.
- 3/4 - Gran variedad de altillos que ofrecen la alternativa de trabajar de pie ofreciendo a su vez soluciones próximas de archivo.
- 5 - Subida vertical de cables integrada en archivo. Doble fondo interior hasta canal de electrificación.
- 6 - Accesibilidad. Módulos accesibles por uno o por los dos lados.
- 7 - Mesas de trabajo con tableros deslizantes y salidas flip top de acceso rápido a las conexiones.
- 8 - Conexión lateral entre armarios. Canal de electrificación central de gran capacidad.

- 1 - The central file supports accessories and channels the wiring.
- 2 - Storage modules with sliding doors, drawers, open bookcases and mixed solutions.
- 3/4 - A great variety of overhead storage which offers the alternative to work standing up at the same time offering filing solutions.
- 5 - Vertical cable climb integrated into the file. Double interior base until the wiring channel.
- 6 - Accessibility. Modules accessible on one or both sides.
- 7 - Desks sliding table tops and flip top outputs for fast access to connections.
- 8 - Side connection in the cabinets. Central electrification channel with great capacity.

- 1 - Le rangement central est le support des accessoires et centralise le câblage.
- 2 - Vaste choix de rangements suspendus pour alterner le travail debout et un agencement de solution de rangement proche.
- 3/4 - Vaste choix de rangements suspendus pour alterner le travail debout et un agencement de solution de rangement proche.
- 5 - Monté de câble vertical intégré au rangement. Double fond jusqu'au canal d'électrification.
- 6 - Accessibilité. Modules accessibles d'un ou des deux côtés.
- 7 - Tables de travail avec plateaux coulissants et sortie de flip top avec un accès rapide aux connexions.
- 8 - Connexion Latérale aux rangements. Canal d'électrification centrale de grande capacité.

- 1 - Auf dem zentralen Archiv ruhen die Zubehörelemente; die Kabel verlaufen durch das Archivmöbel.
- 2 - Aufbewahrungsmodule mit Schiebetüren, Schubladen, offenen Bücherregalen und kombinierten Elementen.
- 3/4 - Dank einer breiten Auswahl an Hochregalen sind die Arbeitsmaterialien auch bei stehender Tätigkeit immer griffbereit.
- 5 - Der vertikale Kabelschacht ist ins Archivmöbel integriert. Doppelter Innenboden bis zum Kabelschacht.
- 6 - Einfacher Zugang. Die Module sind von einer oder von beiden Seiten zugänglich.
- 7 - Arbeitstische mit verschiebbaren Tischplatten und Ausgänge "flip top"-für einen schnellen Zugang zu den Anschlüssen.
- 8 - Seitliche Anschlüsse an den Schränken. Zentraler Kabelkanal hoher Aufnahmekapazität.

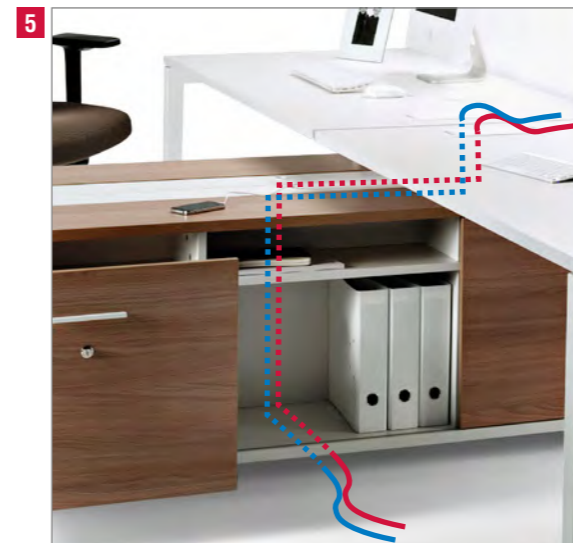

Altillos sobre pared crean un espacio más diáfano y ligero. Las mesas independientes permiten una total flexibilidad.
Fixed overhead storage attached to the wall creates a more transparent and light space. The independent desks enable total flexibility.

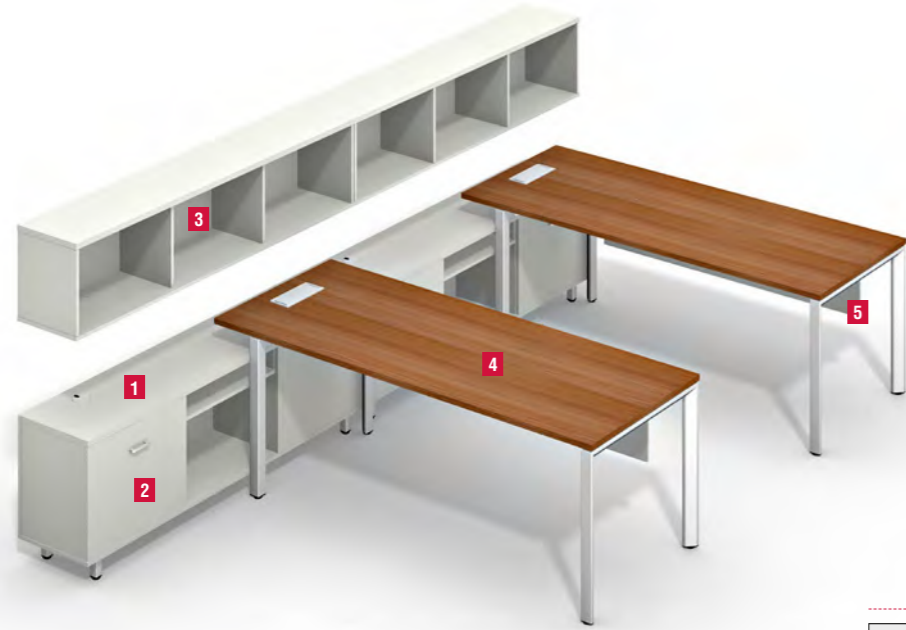

- 1 - Spine Single Module with continuous electrification
- 2 - Pack of 2 Sliding doors for Single Spine Modules
- 3 - Single Overhead Wall storage - 3 Compartments
- 4 - Vital Plus Desk with independent feet and Overlap - Open frame
- 5 - Skirting for desks with independent support

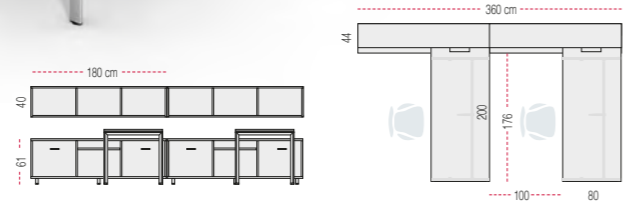

La variedad de altillos permite aportar soluciones de almacenamiento diversas de acuerdo a las necesidades de cada puesto.
The variety of overhead storage enables various storage solutions in accordance with the needs of each position.

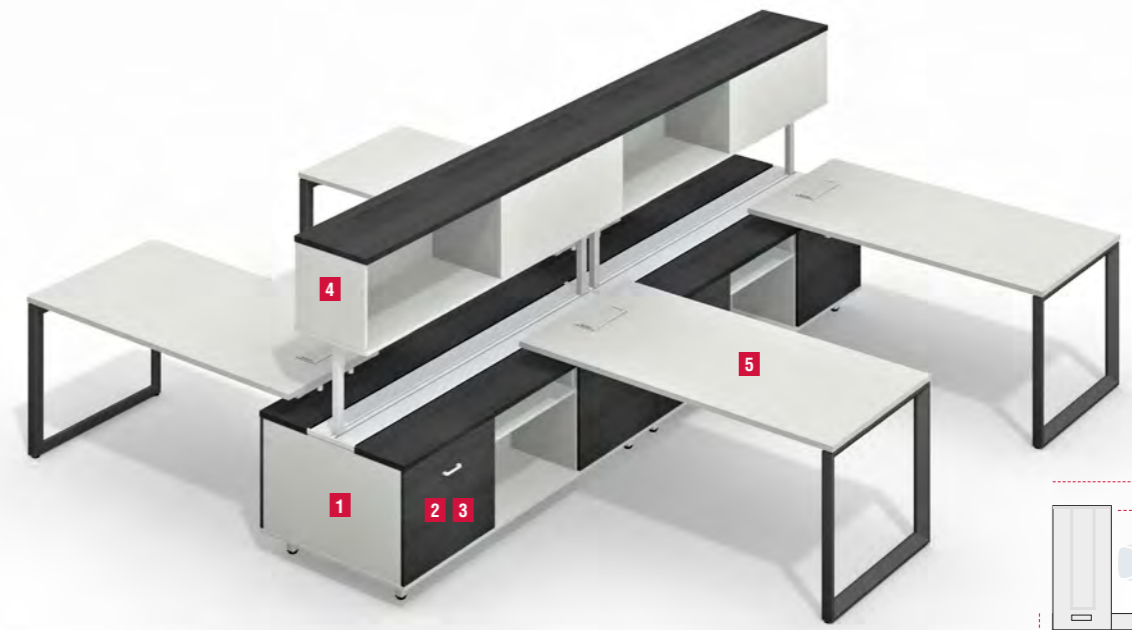

- 1 - Double Spine Module with continuous electrification
- 2 - Pack of 2 Sliding doors for Double Spine Modules
- 3 - Pack of 2 Filing Drawers for Double Spine Modules
- 4 - Overhead storage for use with double Spine Modules - 1 + 1 Compartments
- 5 - Vital Plus individual desks with structure from Spine support - Loop frame

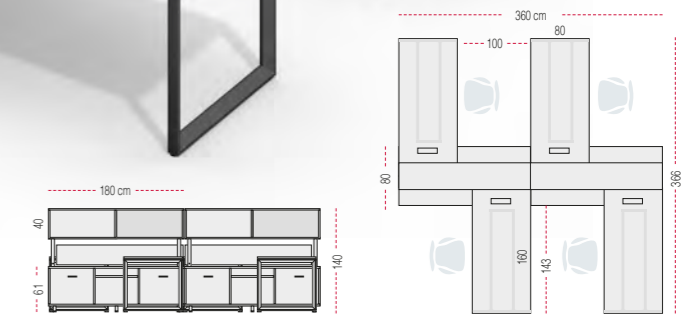

Unión de puesto con puesto por mediación del armario, que además de servir de apoyo para la encimera, ejerce de "columna vertebral" del sistema.
Position of junction for meditation of the cabinet, which furthermore serves as a support for the top, acting as a backbone of the system.



- 1 - Double Spine Module with continuous electrification
- 2 - Pack of 2 Sliding doors for Double Spine Modules
- 3 - Double Overhead storage for use with double Spine Modules - 3 Slots with 2 sliding doors
- 4 - Vital Plus twin desks with structure from Spine support - Open frame
- 5 - Dividers on the table top for Vital Plus twin desks

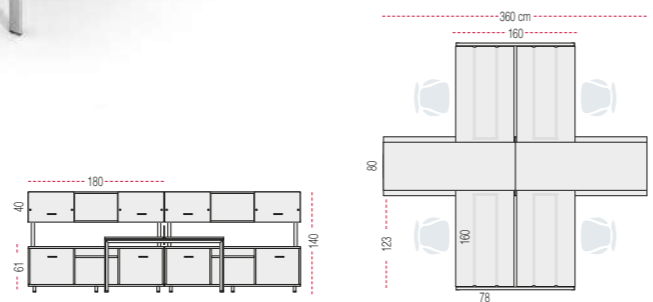

Los módulos auxiliares como bucks y armarios inferiores aportan al puesto de trabajo mayor versatilidad y espacio para objetos personales.
Auxiliary modules such as bucks and lower cabinets provide more versatile workstations with space for personal objects.

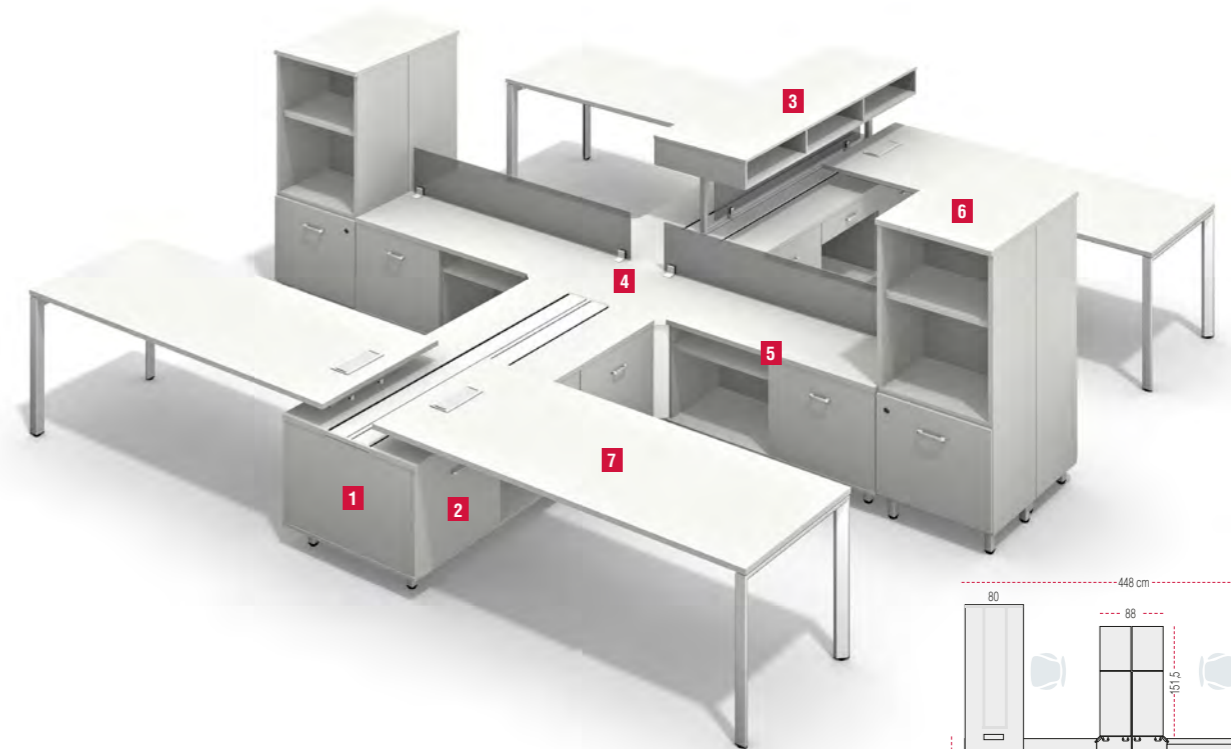

- 1 - Double Spine Module with continuous electrification
- 2 - Pack of 2 Sliding doors for Single Spine Modules
- 3 - Double Overhead Storage-Shelf - 3 +3 Compartments.
- 4 - Junction Cover for 2 double Spine and 2 Low Cabinets
- 5 - Spine auxiliary modules - Low Cabinet 61 cm with filing drawer
- 6 - Spine auxiliary modules - High Cabinet 131 cm with filing drawer
- 7 - Vital Plus Desk with structure from Spine support - Open frame

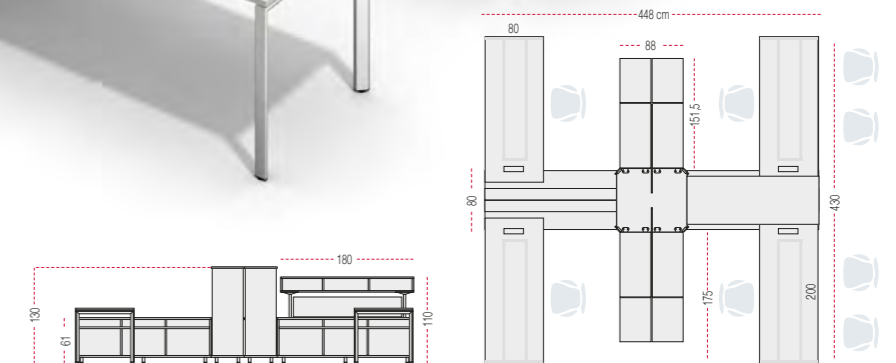

SPINE MODULES - CONTINUOUS ELECTRIFICATION

Double Module Compartment

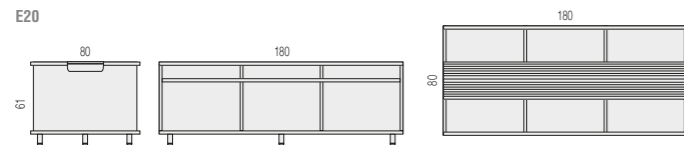

Single Module Compartment

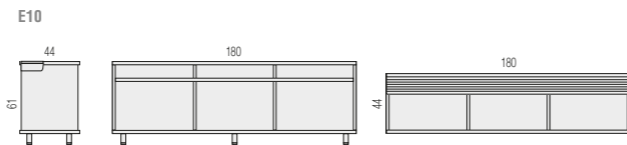

Front Accessories for single and double modules

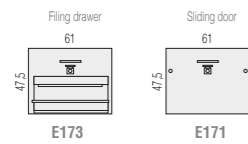

OVERHEAD STORAGE FOR USE WITH SPINE MODULES

DOUBLE STORAGE FOR SPINE

Overhead storage - Shelf 3 +3 Compartments

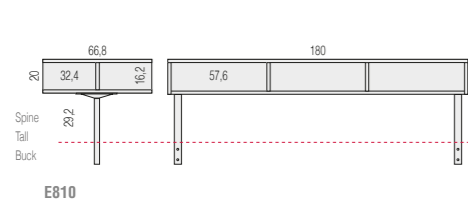

Overhead storage - 1 + 1 Compartments

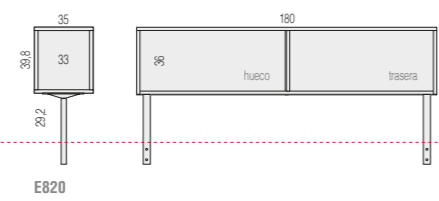

Overhead storage 3 +3 Slots

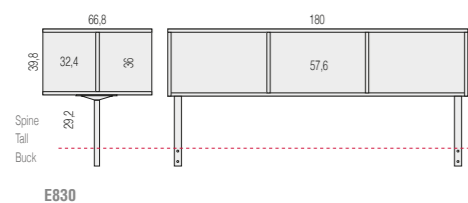

Overhead storage - 3 Slots with 2 sliding doors

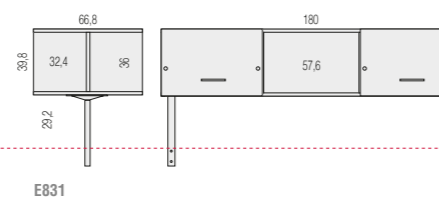

INDIVIDUAL WALL STORAGE FOR SPINE

Overhead Wall storage - 3 Compartments

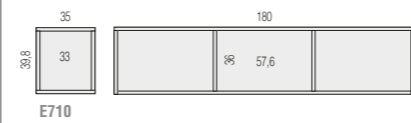

Overhead storage attached to the wall 3 Slots with 2 sliding doors

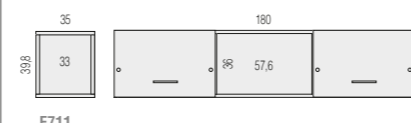

SPINE AUXILIARY MODULES

High Cabinet 130 cm

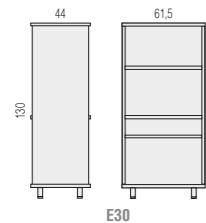

High Cabinet Accessories

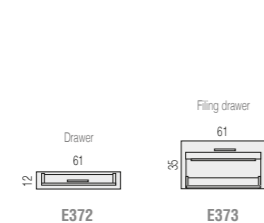

Low Cabinet 61 cm

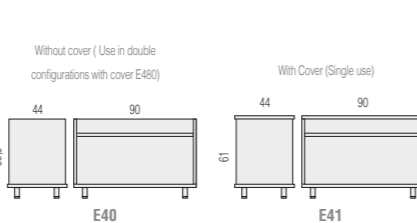

Low Cabinet Accessories

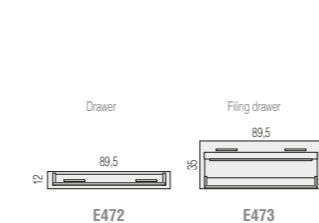

Optional Accessories for low modules 61 cm

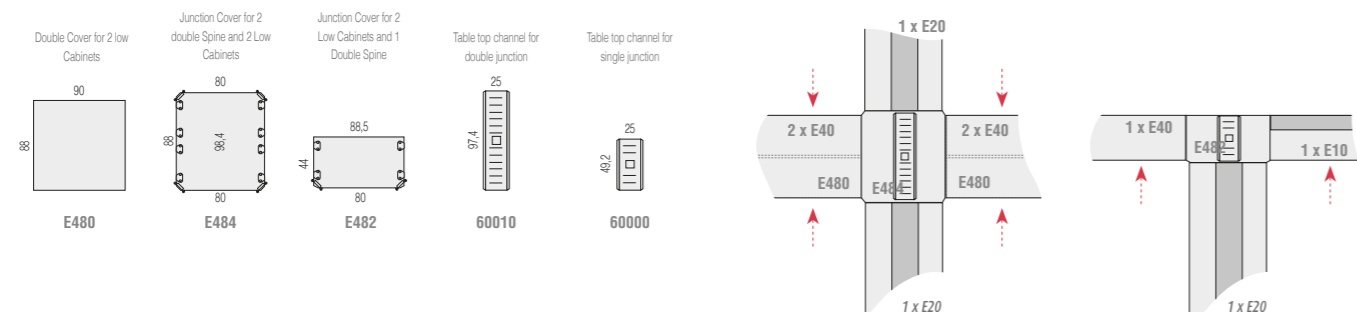

DESKS FOR USE WITH SPINE MODULES

VITAL PLUS DESKS WITH OPEN FRAME

DESKS WITH STRUCTURE FROM SPINE SUPPORT

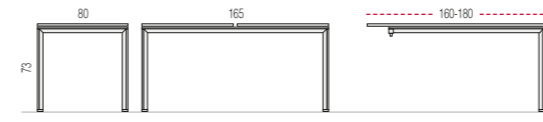

Straight Desks - 80 cm

Double Desks - 165 cm

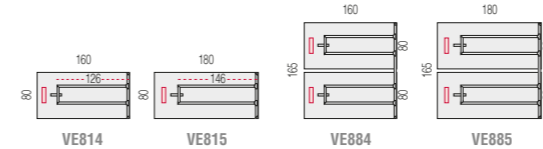

DESKS WITH FLOOR SUPPORT AND OVERLAP WORK-TOP

The desks have Overlap +20 cm, making the space useful for:

- For desks with a table top 180 cm - Useful surface 160 cm
- For desks with a table top 200 cm - Useful surface 180 cm



Straight Desks - 80 cm

Double Desks - 165 cm

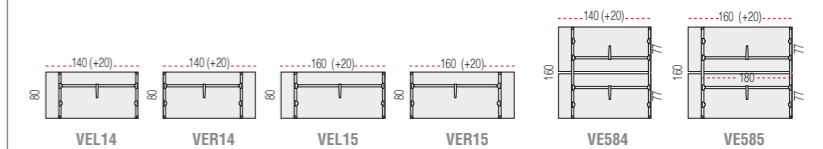

VITAL PLUS DESK WITH CLOSED FRAME

DESKS WITH STRUCTURE SPINE SUPPORT

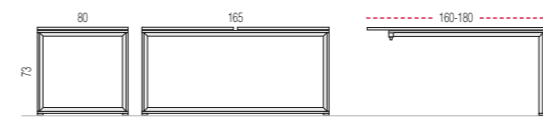

Straight Desks - 80 cm

Double Desks - 165 cm

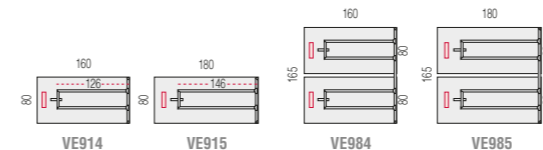

DESKS WITH FLOOR SUPPORT AND OVERLAP WORK-TOP

The desks have Overlap + 20 cm, making the space useful for:

- For desks with a table top 180 cm - Useful surface 160 cm
- For desks with a table top 200 cm - Useful surface 180 cm



Straight Desks - 80 cm

Double Desks - 165 cm

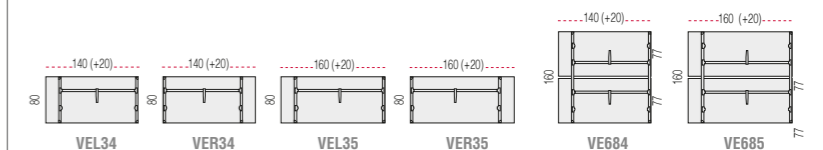

FINISHES

Acabados normalizados en blanco, negro y castaño. Para proyectos que requieran de una personalización específica, Actiu ofrece diversas propuestas de color alternativas.

Standard finishes in white, black and brown. For projects that require specific customization, Actiu offers various proposals in alternative colours.

Les finitions standards sont de couleur blanche, noir et châtain. Actiu, vous propose une autre gamme de couleurs pour des projets bien précis.

Standard-Oberflächen Ausführungen in weißer, schwarzer oder kastanienbrauner Farbe. Wenn Ihr Projekt eine besondere individuelle Gestaltung erfordert, bietet Actiu auch andere farbliche Alternativen.

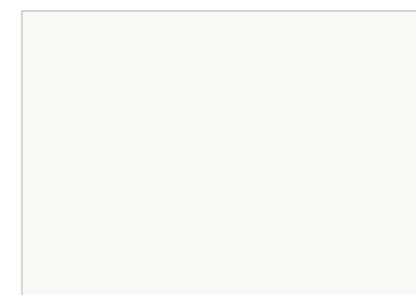

00 WHITE



08 BLACK

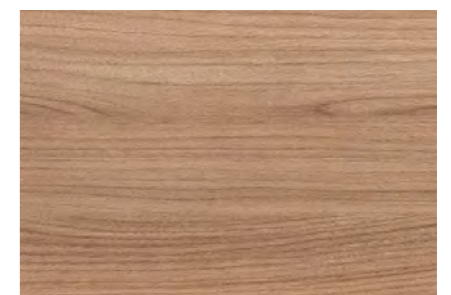

07 CHESTNUT



Spine ofrece soluciones donde el armario modular funge como elemento separador y también conector de las mesas de trabajo.

Spine offers solutions where a modular cabinet acts as a divider and a connector too for work desks.

Spine, vous offre des solutions avec des rangements modulaires comme élément séparateur et en liaison directe avec les tables.

Bei bestimmten Spine-Anordnungen bildet das Schrankmodul gleichzeitig das trennende und das verbindende Element der Arbeitsplätze

Other Solutions

Innovative solutions
for open spaces



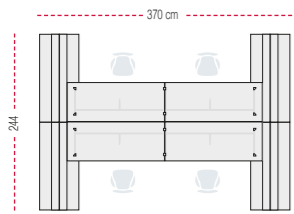

Ligero, flexible, abierto
Los armarios delimitan zonas, estructuran los grandes espacios y pueden utilizarse en su totalidad como espacio de almacenamiento.

Léger, souple, ouvert
Les rangements délimitent les zones, et cloisonnent les grands espaces tout en étant un meuble de rangement

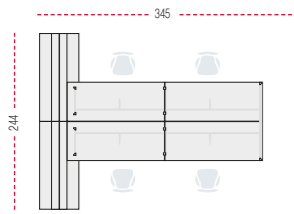

Light, flexible, open
The cabinets identify zones, it structures large spaces and can be used in its entirety as storage space.

Leicht, flexibel und offen
Die Schränke teilen Arbeitsbereiche auf, verleihen großen Räumen Struktur und dienen natürlich der Aufbewahrung.

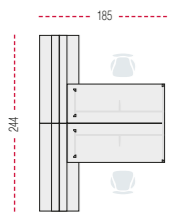

Light, flexible, open



CABINET & PEDESTALS MODULES

Cabinet & pedestal - Single Module

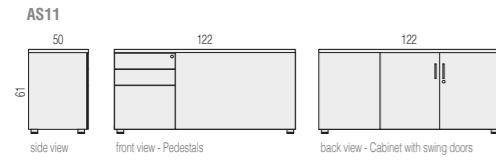

Cabinet & pedestal - Double Module

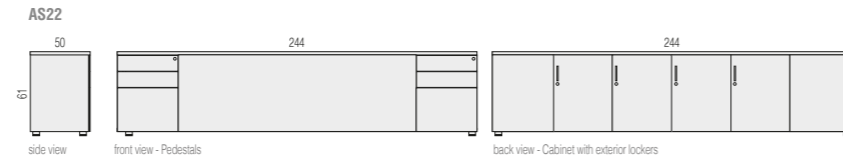
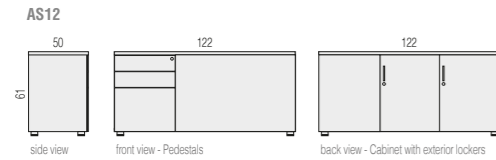
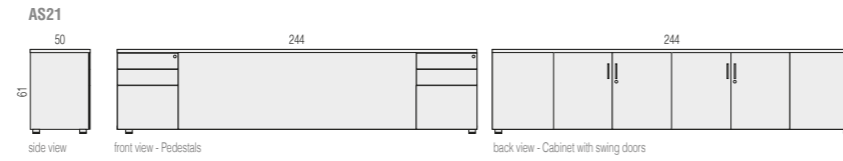

DESKS WITH STRUCTURE FROM CABINET SUPPORT

VITAL PLUS DESKS WITH OPEN FRAME

Straight Desks - 80 cm

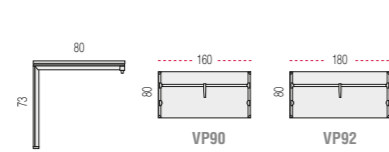
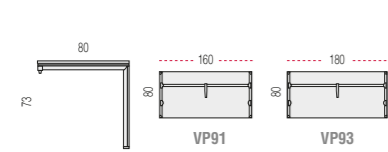

Double Desks - 160 cm

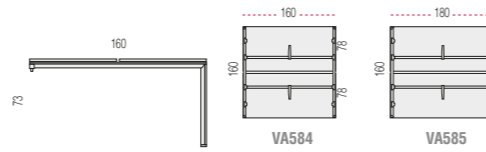

VITAL PLUS DESK WITH CLOSED FRAME

Straight Desks - 80 cm

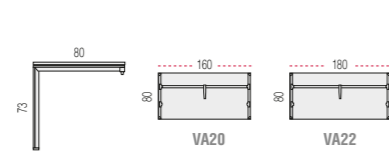
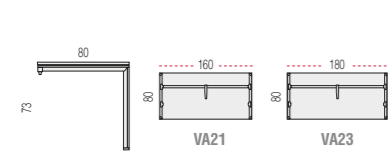

Double Desks - 160 cm

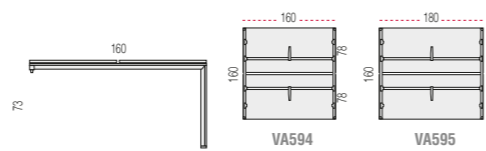

VITAL PLUS DESK WITH TWO CABINETS SUPPORT

Contract Desks (Sharing Middle Leg - Progressive System) - 80cm

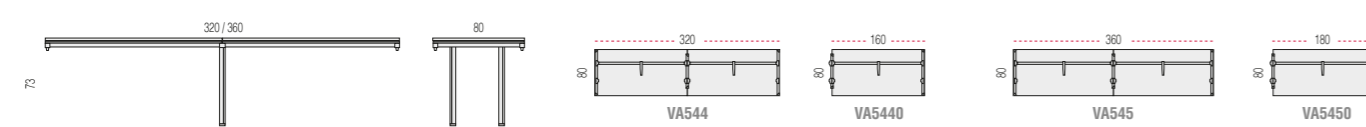

Bench Desks (Sharing Middle Leg - Progressive System) - 160 cm

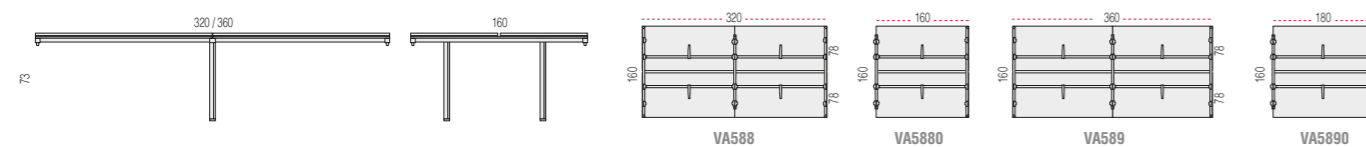

PARQUE TECNOLÓGICO ACTIU

Un proyecto industrial sostenible

Un espacio arquitectónico flexible, abierto y transparente. Un proyecto con nuevas perspectivas, cuya sede corporativa, certificada LEED® Gold para edificios existentes, posiciona a Actiu con referente en Europa en este tipo de certificaciones.

ACTIU TECHNOLOGY PARK

A sustainable industrial project

A flexible, open and transparent architecture space. A project with new prospects certified by LEED® Gold for all the existing buildings that point Actiu as a referent in Europe.



PARQUE TECNOLÓGICO ACTIU
Producción energética planta solar: 7.000.000 kWh/año
Recogida y canalización de aguas pluviales
Depósitos agua: 12.000 m³
Zonas de encuentro, servicios y atención infantil

Zonas verdes: 130.000 m²
Superficie Industrial Total: 200.000 m²
Edificio Corporativo: 6.000 m²
Centro logístico: 18.000 m²
Plantas productivas: 40.000 m²

ACTIU TECHNOLOGY PARK
Energétic production solar plant: 7.000.000 kWh per year
Rainfall water collection (12.000 m³ capacity)
Water Tanks: 12.000 m³
Meeting points, club and nursery service

Green areas: 130.000 m²
Total Industrial surface: 200.000 m²
Corporate Headquarter building: 6.000 m²
Logistics centre: 18.000 m²
Production plants: 40.000 m²



Arquitecto: T.J.Mª - José María Tomás Llavador

DECLARACIÓN AMBIENTAL DE PRODUCTO ENVIRONMENTAL PRODUCT DECLARATION

Análisis de Ciclo de Vida

Life Cycle Analysis



MATERIALES / MATERIALS

Incluye la extracción y transformación de materias primas y el suministro de componentes hasta su entrega en el Parque Tecnológico Actiu. Including the extraction and processing of raw materials and component sourcing to its delivery at the Actiu Technological Park.



PRODUCCIÓN / PRODUCTION

Considera los procesos productivos y de montaje empleados en Actiu. Consider the production and assembly processes used in Actiu.



TRANSPORTE / TRANSPORT

Incluye el transporte desde el Parque Tecnológico Actiu hasta las instalaciones de nuestros clientes, mediante transporte comercial con semirremolque. Includes transportation from the Actiu Technological Park to the our customers facilities (light commercial transport).



USO / USE

Esta etapa no tiene relevancia ambiental para el análisis de ciclo de vida. This stage has not environmental relevance for life cycle analysis.



ELIMINACIÓN / DISPOSAL

Cualquier producto puede eliminarse de distintas maneras, o convertirse en un recurso. El aluminio, madera y cartón del embalaje es reciclado, mientras que el resto es tratado como residuo urbano. Any product can be disposed of in different ways, or become a resource. Aluminum, wood and cardboard packaging is recycled, while the rest is treated as urban waste.

CERTIFICADOS Y REFERENCIAS - CERTIFICATES AND REFERENCES

Actiu y sus productos cumplen las más altas exigencias en la gestión, calidad de producto y sostenibilidad, que aportan valor a los proyectos utilizando materias recicladas y obteniendo un producto final reciclable. Actiu Technological Park and ACTIU' products fulfill all demands about management, quality and sustainability to provide extra value to the projects using recycled materials to get the recyclable final product.

