



Made in the
European Union



3
year
guarantee



Operator chairs
Alter



Features

- 1 **Fabric backrest:** Polypropylene support and shell.
Polyurethane foam density 25 kg/m³, thickness 5 cm.
Mesh backrest: fibreglass reinforced nylon structure, metal rod (steel Q 195).
100% nylon mesh.
- 3 **Seat:** beech plywood underframe and polypropylene shell.
Polyurethane foam density 25 kg/m³, thickness 6 cm.
- 4 **Base:** Nylon 5-point star base, tube \varnothing 60 mm.
Gas-lift mechanism, for seat height adjustments through 6 cm.
Twin wheel swivel castors \varnothing 50 mm, made from nylon, for soft floors.



Option

- 5 **Armrests:**
 - Fixed, made from black polypropylene.
 - 1D in high-resilience plastic

Fabric backrest



Integrated coat hook

Mesh backrest

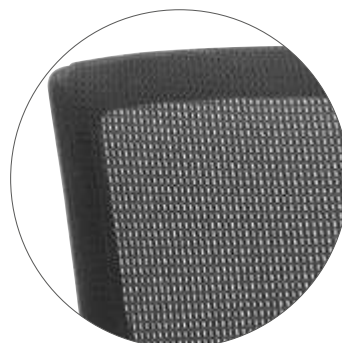

Mechanism

Synchro (Fabric and Mesh backrests)

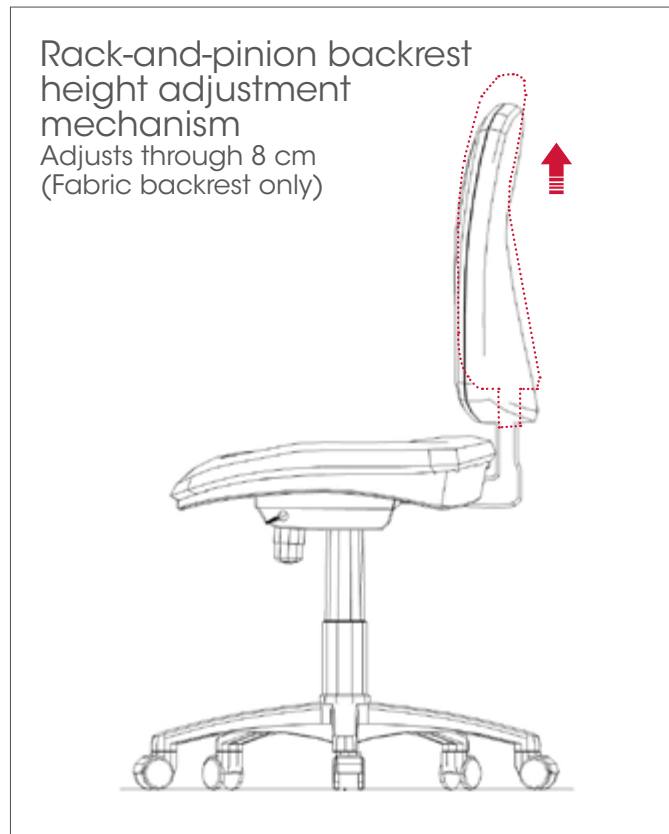
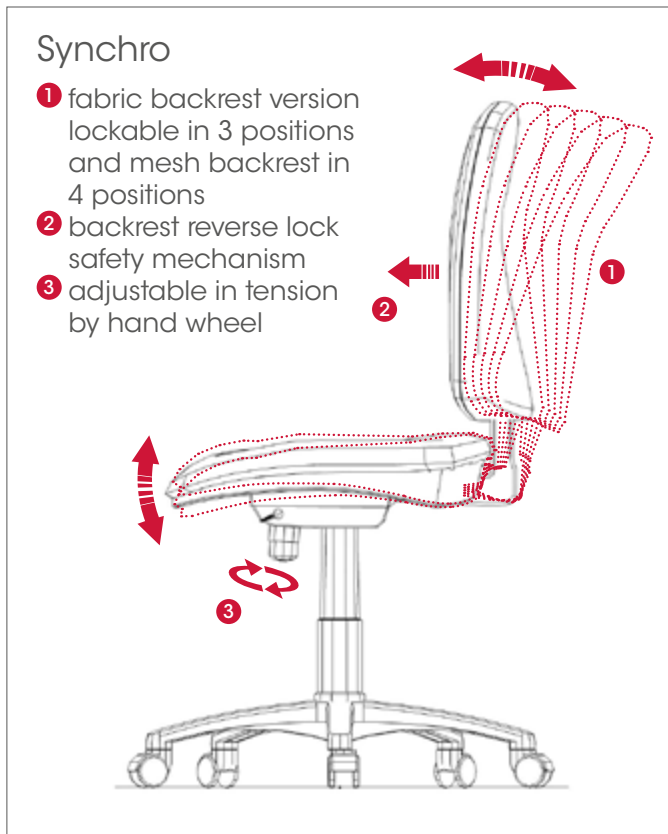

Permanent Contact Mechanism (Fabric backrest)

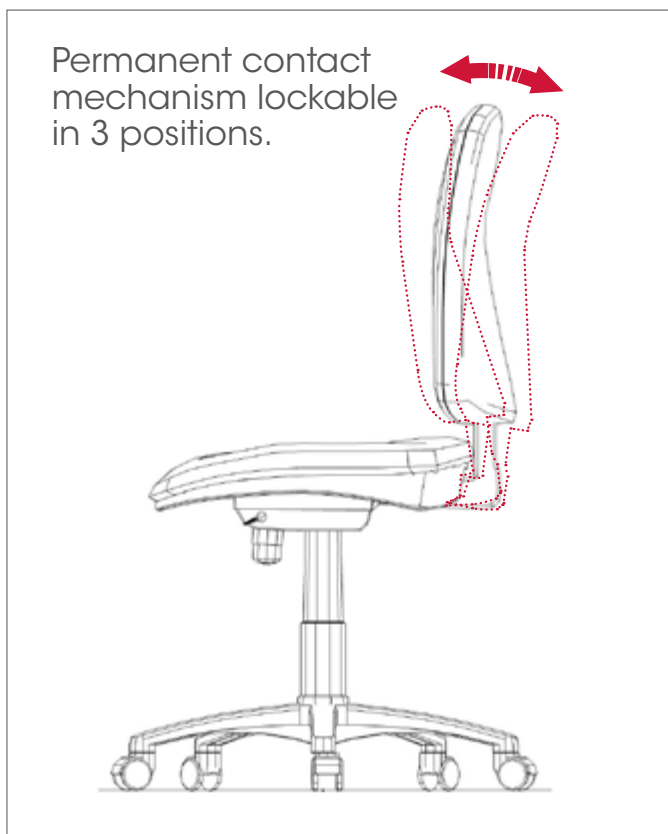

Overview en cm

FABRIC

Without armrests

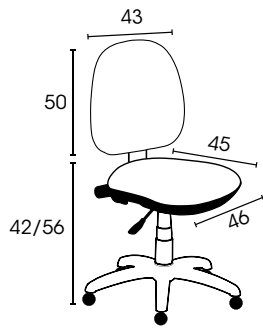

With armrests

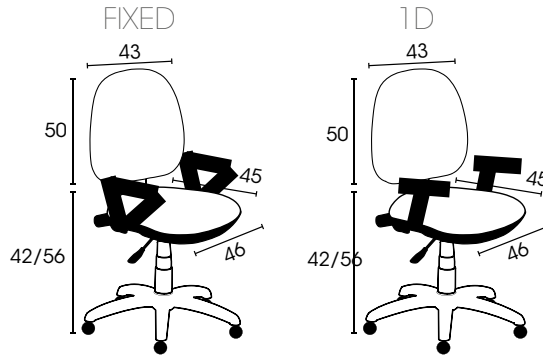

Permanent contact or synchro mechanism

MESH

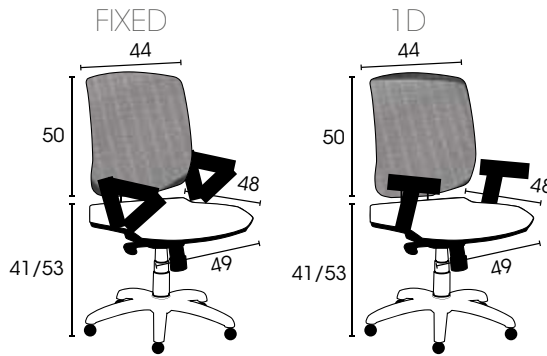
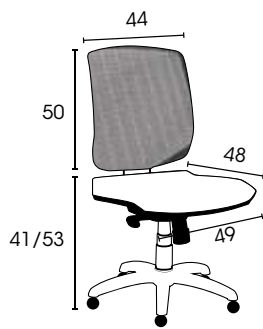

Synchro mechanism

Shade card

FABRICS

Bondai
from stock



Red



Electric blue

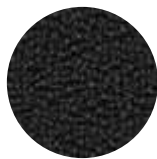

Celestial black

Bondai: 100% polyester fabric, resistance to abrasion: 100,000 cycles, light fastness: 6, flammability: M1 fire-resistant EN 1021-1 and 2