

MEETING
& SHARED SPACES

CREATING VALUE THROUGH COLLECTIVE THINKING

Through a search for collective intelligence, meeting spaces are in flux. Adhering to a more relaxed and progressive way of thinking, modular meeting spaces are emerging with the purpose of sparking creativity and favouring spontaneous exchanges. High tables, mobile and modular lounge furniture, compact and easy to move seating are all now coming to populate meeting spaces. As for traditional meeting rooms, these now come furnished with larger tables, practical and aesthetically pleasing connectivity solutions, as well as comfortable chairs.

Look no further than EOL for solutions to each of these requirements. MODULO lends a touch of tradition and elegance to your meeting rooms. With E-MEETING and its integrated multi-media wall, it is a more modern and cutting-edge approach that you will be embracing.

Meeting tables

E-MEETING	162
MODULO	166
Multi-purpose tables	174

E-MEETING

Conceived as a response to new working modes, E-MEETING is a fully connected solution ready to host all your presentations and video-conferences. Its multimedia wall, complete with built-in power and data feeds and concealed cabling, will accommodate a flatscreen monitor allowing you to bring formal and informal meetings to life.



- Shared workstations, page 57
- Desktop screens, page 99
- Office chairs, page 223
- Accessories, page 253



Classic & versatile



FINISHES & PRODUCT OVERVIEW

4 choices of finish for melamine worktops and legs (+ top)

MG Snow white **RI** Light oak **RL** Amber walnut **MT** Royal brown oak

ON REQUEST

2 choices of metal finish for structure and legs (+ fin.)

SO White **SA** Aluminium grey

ON REQUEST

6 choices of melamine wall finish (+ col.)

MG Snow white **RI** Light oak **RL** Amber walnut **MT** Royal brown oak **M2** Fern green **M4** Sunflower yellow **M1** Cherry red

ON REQUEST

← .5% →

ON REQUEST: allow 6 weeks

Curved worktops

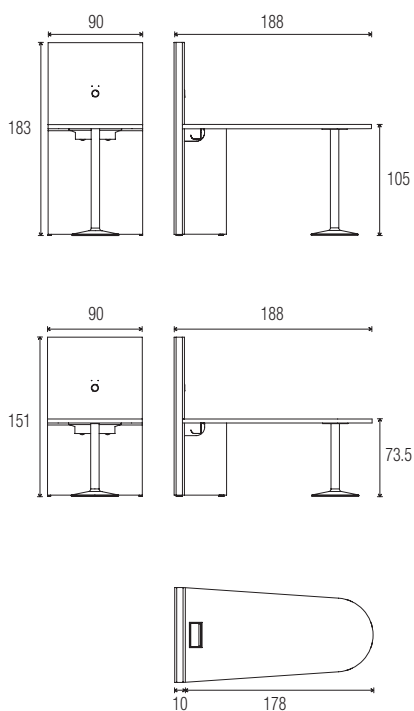

Trapeziform worktops

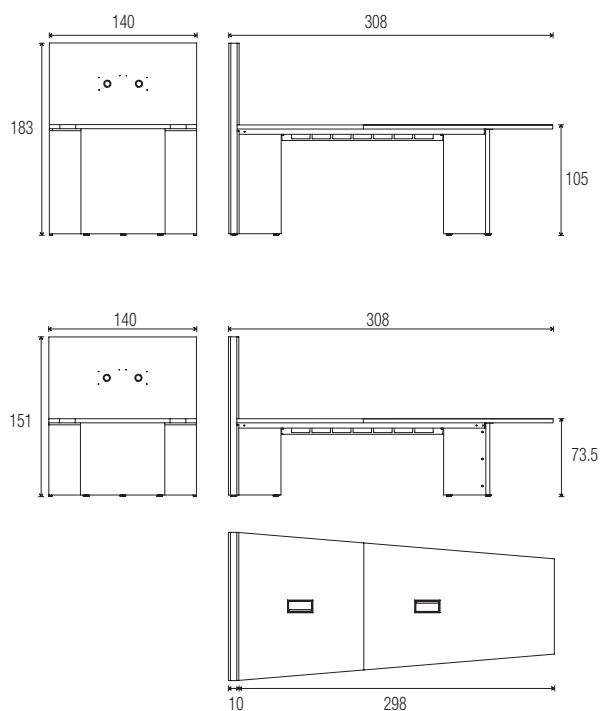

PRICES

Price excl. taxes: **From stock** **On request**

CURVED WORKTOPS - SEAT 5 PEOPLE

Ref. + top + fin. + col.

W. 180 x D. 90 cm. Worktops with opening for one top-access module. Metal cable trough included.



H. 73.5 cm - seated

6 628 040



H. 105 cm - standing

6 628 041

TRAPEZIFORM WORKTOPS - SEAT 7 PEOPLE

W. 300 x D. 140 cm. Worktops with opening for two top access modules. Metal cable trough included.



H. 73.5 cm - seated

6 628 042



H. 105 cm - standing

6 628 043

OPTIONS

Ref.

Flatscreen monitor arm. Designed to be affixed to the wall panel of E-MEETING tables



For 24" monitors (curved worktop)

6 628 044 + SB



For 26" monitors (trapeziform worktop)

6 628 045 + SG



Power and cable management

Optional - see page 273



Top access housing
Module to be ordered separately

MODULO

With 8 different adjoinable worktop shapes and a range of sizes, MODULO offers multiple combinations with which to furnish your meeting spaces. Highly functional, this range integrates power and data management solutions that allow for discreet channelling of cables, along with direct desktop connectivity.





Modular & functional

Melamine worktops
30 or 38 mm thick

Centred top access housing
and cable trough for the storing
of cables on elliptical worktops

Worktops with pre-cut openings
for top access housings, on
rectangular and curved desks



3 TYPES OF LEG DESIGN



Panel
legs



Circular section
metal leg
(with height-adjustment mechanism)



Square section
metal leg

FINISHES & PRODUCT OVERVIEW

3

choices of melamine finish for 38 mm thick worktops and panel legs (+ top)



FROM STOCK

2

choices of melamine finish for 30 mm thick worktops and panel legs (+ top)



FROM STOCK

2

choices of metal finish for legs (+ fin.)



FROM STOCK

ON REQUEST: allow 6 weeks

Rectangular worktop

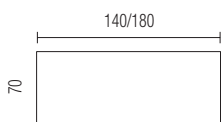

Curved worktop

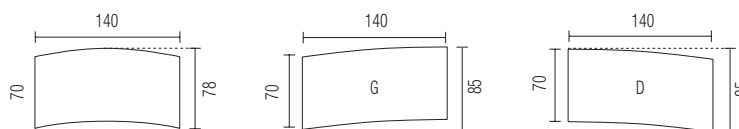

Trapeziform worktop

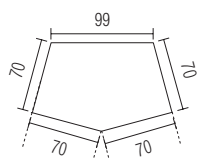

Corner angle worktops

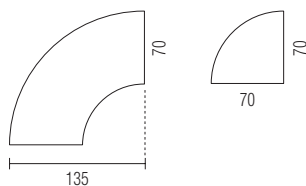

Elliptical worktop

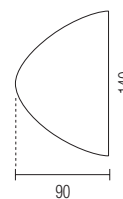

PRICES

Price excl. taxes: **From stock** **On request**

MEETING TABLES WITH WORKTOPS 38 MM THICK

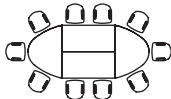
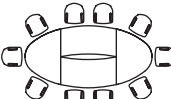
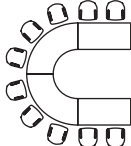
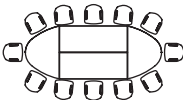
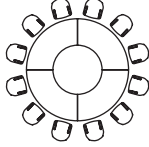
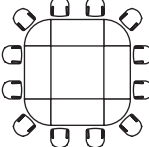
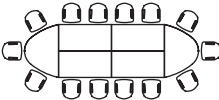
		Worktops WITHOUT opening for top-access		Worktops WITH opening for top-access Supplied with a cable trough	
		Ref.		Ref.	
10 people					
Oval table - W. 320 x D. 140 cm - 2 rectangular worktops W. 140 cm + 2 elliptical worktops					
	Panel legs	6 065 301 + top + top			2 top access housings
	Circular section metal leg	6 065 302 + top + fin.		6 065 343 + top + top	
	Square section metal leg	6 065 303 + top + fin.		6 065 344 + top + fin.	
Elliptical table - W. 320 x D. 156 cm - 2 symmetrical curved worktops + 2 elliptical worktops					
	Panel legs	6 065 304 + top + top			2 top access housings
	Circular section metal leg	6 065 305 + top + fin.		6 065 346 + top + top	
	Square section metal leg	6 065 306 + top + fin.		6 065 347 + top + fin.	
U shaped table - W. 275 x D. 270 cm - 2 rectangular worktops W. 140 cm + two 90° corner angle worktops W. 135 cm					
	Panel legs	6 065 307 + top + top			2 top access housings
	Circular section metal leg	6 065 308 + top + fin.		6 065 349 + top + top	
	Square section metal leg	6 065 309 + top + fin.		6 065 350 + top + fin.	
12 people					
Oval table - W. 360 x D. 140 cm - 2 rectangular worktops W. 180 cm + 2 elliptical worktops					
	Panel legs	6 065 310 + top + top			2 top access housings
	Circular section metal leg	6 065 311 + top + fin.		6 065 352 + top + top	
	Square section metal leg	6 065 312 + top + fin.		6 065 353 + top + fin.	
Circular table - W. 270 x D. 270 cm - four 90° corner angle worktops W. 135 cm					
	Panel legs	6 065 313 + top + top			
	Circular section metal leg	6 065 314 + top + fin.		6 065 354 + top + fin.	
	Square section metal leg	6 065 315 + top + fin.			
Square table - W. 280 x D. 280 cm - 4 rectangular worktops W. 140 cm + four 90° corner angle worktops					
	Panel legs	6 065 316 + top + top			4 top access housings
	Circular section metal leg	6 065 317 + top + fin.		6 065 355 + top + top	
	Square section metal leg	6 065 318 + top + fin.		6 065 356 + top + fin.	
14 people					
Oval table - W. 460 x D. 140 cm - 4 rectangular worktops W. 140 cm + 2 elliptical worktops					
	Panel legs	6 065 319 + top + top			4 top access housings
	Circular section metal leg	6 065 320 + top + fin.		6 065 358 + top + top	
	Square section metal leg	6 065 321 + top + fin.		6 065 359 + top + fin.	



Top access housing
Module to be ordered separately



Power and cable management
Optional - see page 273

PRICES

Price excl. taxes: **From stock** **On request**

MEETING TABLES WITH WORKTOPS 38 MM THICK (continued)

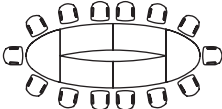
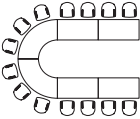
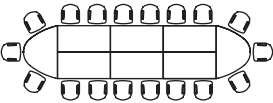
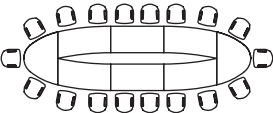
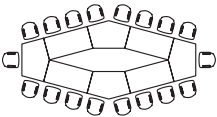
		Worktops WITHOUT opening for top-access		Worktops WITH opening for top-access Supplied with a cable trough	
		Ref.		Ref.	
14 people (continued)					
Elliptical table - W. 460 x D. 170 cm - 4 symmetrical curved worktops + 2 elliptical worktops					
	Panel legs	6 065 322 + top + top		6 065 361 + top + top	
	Circular section metal leg	6 065 323 + top + fin.		6 065 362 + top + fin.	
	Square section metal leg	6 065 324 + top + fin.		6 065 363 + top + fin.	
U shaped table - W. 270 x D. 270 cm - 4 rectangular worktops W. 140 cm + two 90° corner angle worktops W. 135 cm					
	Panel legs	6 065 325 + top + top		6 065 364 + top + top	
	Circular section metal leg	6 065 326 + top + fin.		6 065 365 + top + fin.	
	Square section metal leg	6 065 327 + top + fin.		6 065 366 + top + fin.	
18 people					
Oval table - W. 600 x D. 140 cm - 6 rectangular worktops W. 140 cm + 2 elliptical worktops					
	Panel legs	6 065 328 + top + top		6 065 367 + top + top	
	Circular section metal leg	6 065 329 + top + fin.		6 065 368 + top + fin.	
	Square section metal leg	6 065 330 + top + fin.		6 065 369 + top + fin.	
Elliptical table - W. 600 x D. 170 cm - 4 symmetrical curved worktops + 2 rectangular worktops W. 140 cm + 2 elliptical worktops					
	Panel legs	6 065 331 + top + top		6 065 370 + top + top	
	Circular section metal leg	6 065 332 + top + fin.		6 065 371 + top + fin.	
	Square section metal leg	6 065 333 + top + fin.		6 065 372 + top + fin.	
Hexagonal table - W. 540 x D. 244 cm - 4 trapeziform worktops + 4 rectangular worktops W. 140 cm					
	Panel legs	6 065 334 + top + top		6 065 373 + top + top	
	Circular section metal leg	6 065 335 + top + fin.		6 065 374 + top + fin.	
	Square section metal leg	6 065 336 + top + fin.		6 065 375 + top + fin.	

DESK EXTENSION KIT FOR WORKTOPS 38 MM THICK

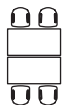
4 people**Rectangular table W. 140 cm** - 2 rectangular worktops W. 140 cm

Panel legs	6 065 337 + top + top
Circular section metal leg	6 065 338 + top + fin.
Square section metal leg	6 065 339 + top + fin.

2 top access housings

6 065 376 + top + top
6 065 377 + top + fin.
6 065 378 + top + fin.

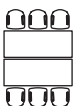
6 people**Rectangular table W. 180 cm** - 2 rectangular worktops W. 180 cm + reinforcement beam

Panel legs	6 065 340 + top + top
Circular section metal leg	6 065 341 + top + fin.
Square section metal leg	6 065 342 + top + fin.

2 top access housings

6 065 379 + top + top
6 065 380 + top + fin.
6 065 381 + top + fin.

MEETING TABLES WITH WORKTOPS 30 MM THICK

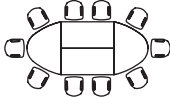
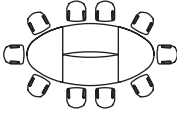
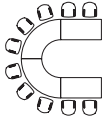
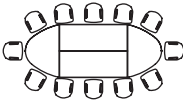
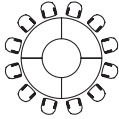
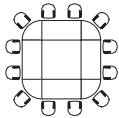
	Worktops WITHOUT opening for top-access		Worktops WITH opening for top-access Supplied with a cable trough	
	Ref.		Ref.	
10 people				
Oval table - W. 320 x D. 140 cm - 2 rectangular worktops W. 140 cm + 2 elliptical worktops			2 top access housings	
	Panel legs	6 065 500 + top + top		6 065 542 + top + top
	Circular section metal leg	6 065 501 + top + fin.		6 065 543 + top + fin.
	Square section metal leg	6 065 502 + top + fin.		6 065 544 + top + fin.
Elliptical table - W. 320 x D. 156 cm - 2 symmetrical curved worktops + 2 elliptical worktops			2 top access housings	
	Panel legs	6 065 503 + top + top		6 065 545 + top + top
	Circular section metal leg	6 065 504 + top + fin.		6 065 546 + top + fin.
	Square section metal leg	6 065 505 + top + fin.		6 065 547 + top + fin.
U shaped table - W. 275 x D. 270 cm - 2 rectangular worktops W. 140 cm + two 90° corner angle worktops W. 135 cm			2 top access housings	
	Panel legs	6 065 506 + top + top		6 065 548 + top + top
	Circular section metal leg	6 065 507 + top + fin.		6 065 549 + top + fin.
	Square section metal leg	6 065 508 + top + fin.		6 065 550 + top + fin.
12 people				
Oval table - W. 360 x D. 140 cm - 2 rectangular worktops W. 180 cm + 2 elliptical worktops			2 top access housings	
	Panel legs	6 065 509 + top + top		6 065 551 + top + top
	Circular section metal leg	6 065 510 + top + fin.		6 065 552 + top + fin.
	Square section metal leg	6 065 511 + top + fin.		6 065 553 + top + fin.
Circular table - W. 270 x D. 270 cm - 4 90° corner angle worktops W. 135 cm				
	Panel legs	6 065 512 + top + top		
	Circular section metal leg	6 065 513 + top + fin.		
	Square section metal leg	6 065 514 + top + fin.		
Square table - W. 280 x D. 280 cm - 4 rectangular worktops W. 140 cm + four 90° corner angle worktops			4 top access housings	
	Panel legs	6 065 515 + top + top		6 065 554 + top + top
	Circular section metal leg	6 065 516 + top + fin.		6 065 555 + top + fin.
	Square section metal leg	6 065 517 + top + fin.		6 065 556 + top + fin.

 **Top access housing**
Module to be ordered separately

 **Power and cable management**
Optional - see page 273

FINISHES

Choice of finish for 38 mm thick worktops and panel legs (+ top)			Choice of finish for 30 mm thick worktops and panel legs (+ top)		Choice of metal finish for legs (+ fin.)	
						
RI	RL	MT	MG	RI	SO	SA
FROM STOCK			FROM STOCK		FROM STOCK	

PRICES

Price excl. taxes: **From stock** **On request**

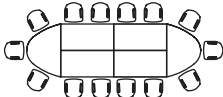
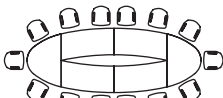
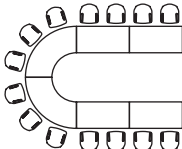
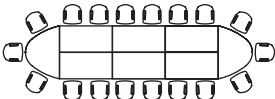
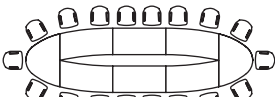
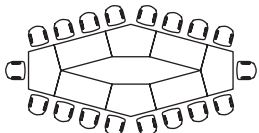

MEETING TABLES WITH WORKTOPS 30 MM (continued)

		Worktops WITHOUT opening for top-access		Worktops WITH opening for top-access Supplied with a cable trough 	
		Ref.		Ref.	
14 people					
Oval table - W. 460 x D. 140 cm - 4 rectangular worktops W. 140 cm + 2 elliptical worktops					
	Panel legs	6 065 518 + top + top			4 top access housings
	Circular section metal leg	6 065 519 + top + fin.		6 065 557 + top + top	
	Square section metal leg	6 065 520 + top + fin.		6 065 558 + top + fin.	
Elliptical table - W. 460 x D. 170 cm - 4 symmetrical curved worktops + 2 elliptical worktops					
	Panel legs	6 065 521 + top + top			4 top access housings
	Circular section metal leg	6 065 522 + top + fin.		6 065 560 + top + top	
	Square section metal leg	6 065 523 + top + fin.		6 065 561 + top + fin.	
U shaped table - W. 270 x D. 270 cm - 4 rectangular worktops W. 140 cm + two 90° corner angle worktops W. 135 cm					
	Panel legs	6 065 524 + top + top			4 top access housings
	Circular section metal leg	6 065 525 + top + fin.		6 065 563 + top + top	
	Square section metal leg	6 065 526 + top + fin.		6 065 564 + top + fin.	
18 people					
Oval table - W. 600 x D. 140 cm - 6 rectangular worktops W. 140 cm + 2 elliptical worktops					
	Panel legs	6 065 527 + top + top			6 top access housings
	Circular section metal leg	6 065 528 + top + fin.		6 065 566 + top + top	
	Square section metal leg	6 065 529 + top + fin.		6 065 567 + top + fin.	
Elliptical table - W. 600 x D. 170 cm - 4 asymmetrical curved worktops + 2 rectangular worktops W. 140 cm + 2 elliptical worktops					
	Panel legs	6 065 530 + top + top			6 top access housings
	Circular section metal leg	6 065 531 + top + fin.		6 065 568 + top + top	
	Square section metal leg	6 065 532 + top + fin.		6 065 570 + top + fin.	
Hexagonal table - W. 540 x D. 244 cm - 4 trapeziform worktops + 4 rectangular worktops W. 140 cm					
	Panel legs	6 065 533 + top + top			4 top access housings
	Circular section metal leg	6 065 534 + top + fin.		6 065 569 + top + top	
	Square section metal leg	6 065 535 + top + fin.		6 065 571 + top + fin.	

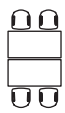

 **Top access housing**
Module to be ordered separately

 **Power and cable management**
Optional - see page 273

DESK EXTENSION KIT FOR WORKTOPS 30 MM THICK

		Worktops WITHOUT opening for top-access		Worktops WITH opening for top-access Supplied with a cable trough 	
		Ref.		Ref.	
4 people					
	Rectangular table W. 140 cm - 2 rectangular worktops W. 140 cm 2 top access housings				2 top access housings
	Panel legs	6 065 536 + top + top		6 065 575 + top + top	
	Circular section metal leg	6 065 537 + top + fin.		6 065 576 + top + fin.	
	Square section metal leg	6 065 538 + top + fin.		6 065 577 + top + fin.	
6 people					
	Rectangular table W. 180 cm - 2 rectangular worktops W. 180 cm + reinforcement beam + 2 top access housings				2 top access housings
	Panel legs	6 065 539 + top + top		6 065 578 + top + top	
	Circular section metal leg	6 065 540 + top + fin.		6 065 579 + top + fin.	
	Square section metal leg	6 065 541 + top + fin.		6 065 580 + top + fin.	

OPTIONS

		Metal		Altuglas®	
		Ref.		Ref.	
Centred top access module + cable trough kit for elliptical tables					
Kit comprising a top access housing with a cover, in either metal (Aluminium grey SA or White SO) or 6 mm thick Altuglas (White OA), in addition to a cable trough for the storage of wires and PDA sockets.					
	W. 320 x D. 156 cm	6 065 146 + fin.		6 065 147 + OA	
	W. 460 x D. 170 cm	6 065 149 + fin.		6 065 150 + OA	
	W. 600 x D. 170 cm	6 065 152 + fin.		6 065 153 + OA	
	Extension kit W. 140 cm	6 065 600 + fin.		6 065 601 + OA	
	Extension kit W. 180 cm	6 065 602 + fin.		6 065 603 + OA	
Modesty panels for metal legs (not compatible with version featuring top access)					
Metal - H. 28 cm					
	W. 50.5 cm - for 90° corner angle W. 70 cm	6 059 123 + fin.			
	W. 127 cm - for worktops W. 140 cm and 90° corner angle W. 135 cm	6 059 122 + fin.			
	W. 167 cm - for worktops W. 180 cm	6 059 150 + fin.			

FINISHES					
Choice of finish for 38 mm thick worktops and panel legs (+ top)			Choice of finish for 30 mm thick worktops and panel legs (+ top)		Choice of metal finish for legs (+ fin.)
					
RI	RL	MT	MG	RI	SO
FROM STOCK			FROM STOCK		FROM STOCK

MULTI-PURPOSE TABLES

Thanks to their wide array of shapes and sizes, multi-purpose tables allow you to create multiple configurations when fitting out your meeting spaces.

+ Light weight & modular

Metal structural frame
40 x 20 mm in a Graphite grey finish

Melamine worktops
19 mm thick



Square section 30 x 30 mm
metal legs with mounted on
adjustable stabilizer feet.



FINISHES & PRODUCT OVERVIEW

4

choices of melamine worktop (+ top)



MG
Snow white



M6
Cashmere grey



R2
Honfleur beech wood



RI
Light oak

FROM STOCK

3

choices of metal finish for legs (+ fin.)

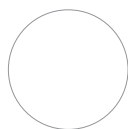

SO
White



SA
Aluminium grey



SC
Graphite grey

FROM STOCK

Standard worktops

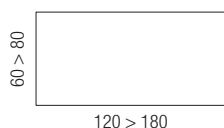

Half-moon worktops

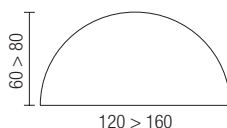

Trapeziform worktops

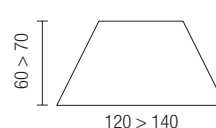

PRICES

Price excl. taxes: **From stock** **On request**

RECTANGULAR TABLES



W. 120 x D. 60 cm

Ref. + top + fin.

6 298 013

W. 140 x D. 70 cm

6 298 017

W. 160 x D. 80 cm

6 298 021

W. 180 x D. 80 cm

6 298 024

HALF-MOON TABLES



W. 120 x D. 60 cm

6 298 001

W. 140 x D. 70 cm

6 298 005

W. 160 x D. 80 cm

6 298 009

TRAPEZIFORM TABLES



W. 120 x D. 60 cm

6 298 025

W. 140 x D. 70 cm

6 298 029

FURNISHING EMERGING TRENDS

Currently in full flux, spaces originally dedicated exclusively to restaurant type uses are gradually opening up to new uses.

More mobile than ever, seeking out spaces for gatherings or to concentrate in, employees intuitively head for the restaurant area in pursuit of relaxation, to conduct informal exchanges or even a business meeting...

At the heart of this new trend, furnishing concepts that are adaptive, versatile, convivial, and where comfort blends with the aesthetically pleasing.

Here at EOL, this trend has not gone unnoticed.

We offer you modular and flexible product ranges, allowing for a quick and easy reconfiguration of your spaces thanks to our flip-top and folding tables.

The OUTDOOR and EVASION furniture ranges will enable you to create spaces that are modern, inviting and cosy.

Multi-purpose tables

Flip-top tables	178
Folding tables	180
ELOISE 	182
EVASION	186
Outdoor tables	189
Open sided easy access tables	190

FLIP-TOP TABLES

+ Simple & handy



Melamine worktops
25 mm thick

Square section tubular structure
40 x 40 mm, mounted on
2 metal hinge plates

Easy to move around
thanks to its 4 castors
(Ø75 mm) with 360° swivel
action (2 with brakes)

IN FOCUS



Simple folding mechanism
ensuring fast and safe
handling by one person



Thumbscrews allow a quick
and easy **tool-free assembly**



Easy storage: with their tops
in vertical storage position,
tables can be nested with
one another



FINISHES & PRODUCT OVERVIEW

5

choices of melamine worktops (+ top)

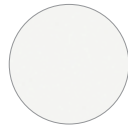

MG
Snow white



M6
Cashmere grey



MA
White maple



R2
Honfleur beech wood



RI
Light oak

FROM STOCK

2

choices of metal finish for legs (+ fin.)

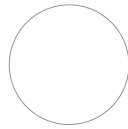

SO
White



SA
Aluminium grey

FROM STOCK

Standard worktops

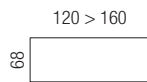
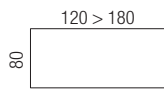

Half-moon extensions

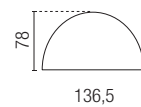
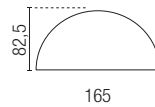

PRICES

Price excl. taxes: **From stock** **On request**

RECTANGULAR TABLES

H. 73.5 cm



W. 120 x D. 80 cm

Ref. + top + fin.

6 421 053

W. 140 x D. 80 cm

6 421 050

W. 160 x D. 80 cm

6 421 051

W. 180 x D. 80 cm

6 421 054



W. 120 x D. 68 cm

6 421 055

W. 140 x D. 68 cm

6 421 056

W. 160 x D. 68 cm

6 421 057

HALF-MOON EXTENSIONS



W. 165 x D. 82.5 cm

6 421 052



W. 136 x D. 78 cm

6 421 058

MODULAR FOLDING TABLES

+ Lightweight & robust

Edge banding in a matching colour to the worktop

Melamine worktops
25 mm thick



IN FOCUS



Black protective grommets
for table stacking and storage



Hinge mechanism for quick
assembly and stacking



MODULAR FOLDING TABLES

Rectangular tables - H. 72 cm



W.120 x D. 80 cm

Ref. + top + SQ

6 275 050

W. 140 x D. 70 cm

6 275 051

W.160 x D. 80 cm

6 275 052

Half-moon extensions - H. 72 cm

For pairing with 2 non-modular rectangular tables



W. 140 x D. 70 cm

6 275 053

W. 160 x D. 80 cm

6 275 054

FINISHES

Choice of melamine worktops (+ top)



M6
Cashmere grey



R2
Honfleur beech wood

Choice of metal finish for legs (+ fin.)



SQ
Chrome

STOCK

INDIVIDUAL FOLDING TABLES



Rectangular tables H. 73 cm

Melamine worktops 18 mm thick, in a Light grey finish (GR). Double steel reinforcement bar under the worktop. Bridge design lower leg section in a Black finish (SG).



W. 120 x D. 80 cm

Ref.

6 337 020 + GR + SG

W. 160 x D. 80 cm

6 337 021 + GR + SG

TRANSPORT TROLLEY



Ideal for transporting and storing folded tables

Carries up to 10 folding tables, 20 chairs (4 feet) for shared spaces or 14 folding chairs. Strap included for securing of folding chairs.



W. 70 x D. 160 cm

Ref.

6 275 044 + SC

ON REQUEST: allow 6 weeks

ELOISE

Perfect for the fitting out of meeting and/or restaurant spaces, ELOISE free-standing tables offer an extensive selection of leg designs and worktop thicknesses to choose from. In combining a high degree of practicality with a sturdy design, this range answers all your furnishing needs.



- Office chairs, page 223
- Decorative plants, page 260



A comprehensive range



2 heights for central stem and panel leg tables available
H. 73.5 and 105 cm

new

Cable management through central stem or top access housing, depending on the table model

Melamine worktop
38 mm or 25 mm thick, depending on the table model

5 TYPES OF LEG DESIGN



Circular central stem and base plate
H. 73.5 and 106 cm



Square central stem and base plate
H. 73.5 and 106 cm



Circular section
H. 73.5 cm













Square section
H. 73.5 cm

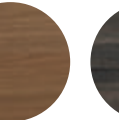

Panel
H. 74.8 and 105 cm

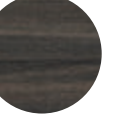
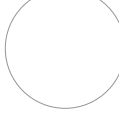
FINISHES & PRODUCT OVERVIEW

7	choices of melamine finish for 25 mm thick worktops (+ top)	 MG Snow white	 M6 Cashmere grey	 MA White maple	 R2 Honfleur beech wood	 RI Light oak	 RL Amber walnut	 MT Royal brown oak	FROM STOCK
4	choices of melamine finish for 38 mm thick worktops (+ top)	 MG Snow white	 RI Light oak	 RL Amber walnut	 MT Royal brown oak				FROM STOCK
3	choices of metal finish for legs (+ fin.)*	 SO White	 SA Aluminium grey	 SC Graphite grey				FROM STOCK	

* Depending on the model.

ON REQUEST: allow 6 weeks

Worktops 25 mm thick
(availability dependent on chosen height)

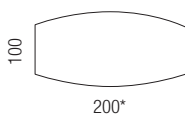
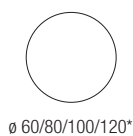

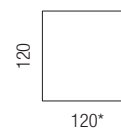
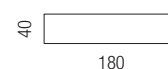
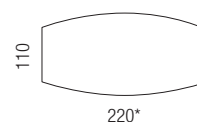
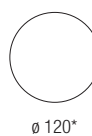

Worktops 38 mm thick
(availability dependent on chosen height)



* Also available in version with pre-cut opening for top access housings. 

PRICES

Price excl. taxes: **From stock** **On request**

CIRCULAR SECTION METAL LEG		Central leg		4 legs	
		Ref. + top + fin.		Ref. + top + fin.	
	H. 73.5 cm - Worktops 25 mm thick - worktops ø 100 and 120 cm with cable port openings				
	Ø 80 cm	6 238 142		-	
	Ø 100 cm standard leg	6 238 128		6 238 119	
	Ø 100 cm leg with cable management*	6 238 162		-	
	Ø 120 cm standard leg	6 238 129		6 238 120	
	Ø 120 cm leg with cable management*	6 238 163		-	
	H. 73.5 cm - Worktops 38 mm thick - Ø 120 cm with cable port openings				
	Ø 120 cm standard leg	6 238 156		6 238 157	
	Ø 120 cm leg with cable management*	6 238 164		-	
	H. 106 cm - Worktops 25 mm thick - from stock availability in MG and RI finish only.				
Ø 60 cm	6 488 003		-		
	H. 73.5 cm - Worktops 25 mm thick				
	W. 200 x D. 100 cm	6 238 134		6 238 131	
	W. 200 x D. 100 cm with opening for top access module**	6 238 152		6 238 153	
	H. 73.5 cm - Worktops 38 mm thick				
	W. 220 x D. 110 cm	6 238 138		6 238 159	
	W. 220 x D. 110 cm with opening for top access module**	6 238 158		6 238 160	

SQUARE SECTION METAL LEGS

Square tables. From stock availability in MG and RI finish only.

	H. 73.5 cm - Worktops 25 mm thick				
	W. 80 x D. 80 cm	6 444 003		-	
	H. 73.5 cm - Worktops 38 mm thick				
	W. 120 x D. 120 cm	-		6 238 154	
	W. 120 x D. 120 cm with opening for top access module**	-		6 238 155	
	H. 106 cm - Worktops 25 mm thick				
W. 80 x D. 80 cm	6 444 004		-		

MELAMINE PANEL LEGS

Rectangular tables.



H. 74.8 cm - Worktops and legs 38 mm thick

W.140 x D. 80 cm

6 440 040 + MG

W. 180 x D. 80 cm

6 440 041 + MG

W. 220 x D. 80 cm

6 440 042 + MG

H. 105 cm - Worktops and legs 38 mm thick - Footrest bar in a white finish

W. 140 x D. 80 cm

6 440 043 + MG + SO

W. 180 x D. 80 cm

6 440 044 + MG + SO

W. 220 x D. 80 cm

6 440 045 + MG + SO

W. 180 x D. 40 cm

6 440 046 + MG + SO



Power and cable management

Optional - see page 273



Top access housing

Module to be ordered separately

* The central stem leg with cable management allows wires to be fed through the upright and out under the raised base plate mounted on glides. The cable port is to be ordered separately.

** Worktops with pre-cut openings for top access housings are supplied fitted with a cable trough. The housing module is to be ordered separately.

EVASION

Subtly combining metal with natural beech wood, the EVASION range appeals thanks to its light and contemporary styling. Available in several shapes and sizes, EVASION fits in just as easily within restaurant spaces as it does in meeting spaces.



- EVASION low tables, page 22
- EVASION bench units, page 32
- EVASION chairs, page 236



Modern & inviting



Stain and scratch-resistant
laminated worktops,
23.5 mm thick

Solid beech legs topped
with metal mounting
brackets and adjustable
stabilizer feet.

new

New choice of colours

2 table top heights
H. 73.5 and 110 cm

IN FOCUS



Metal underframe in a
matching colour finish
to the worktop



Beech plywood
edge banding

FINISHES & PRODUCT OVERVIEW

4 choices of laminate finish for worktops 23.5 mm thick (+ top)

4 choices of metal finish for legs (+ fin.)

FROM STOCK

ON REQUEST

ON REQUEST: allow 6 weeks

Options include: HZ (White laminate), VW (Black laminate), VX (Cherry red), VY (Sunflower yellow), ZO MS (White / Solid beech), ZP MS (Black / Solid beech), X6 MS (Red / Beech), X5 MS (Yellow / Beech).

Discounts: -5% for combinations of laminate and metal finishes.



PRICES

Price excl. taxes: **From stock** **On request**

EVASION TABLES		Ref. + top + fin.
	H. 73.5 cm	
	W. 80 x D. 80 cm	6 634 050
	W. 120 x D. 80 cm	6 634 016
	W. 140 x D. 80 cm	6 634 017
	W. 160 x D. 80 cm	6 634 018
	Ø 120 CM	6 634 019
	H. 110 cm	
	W. 80 x D. 80 cm	6 634 051
	W. 160 x D. 80 cm	6 634 020
	W. 240 x D. 80 cm (6 legs)	6 634 052
	W. 160 x D. 160 cm	6 634 053

OUTDOOR USE TABLES

Metallic legs and table top protected from corrosion thanks to a moisture and UV-resistant coating

Worktop Ø 69 cm, fixed or folding

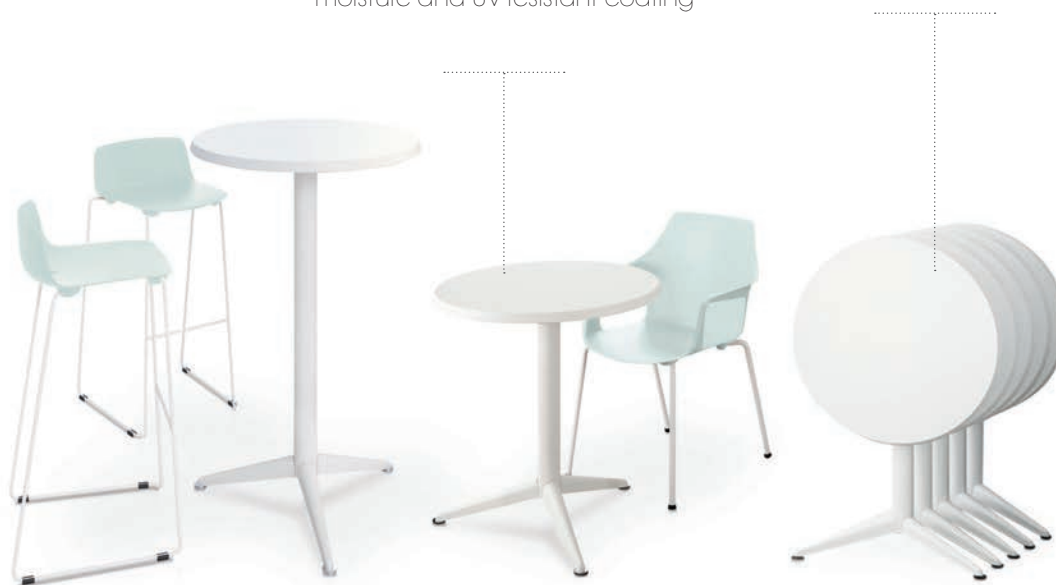

PRICES

Price excl. taxes: **From stock** **On request**



OUTDOOR USE TABLES *

H. 73 cm



Fixed worktop
Folding worktop

6 442 001 + S0
6 442 002 + S0

H. 110 cm



Fixed worktop
Folding worktop

6 442 003 + S0
6 442 005 + S0

Ref.	
6 442 001 + S0	
6 442 002 + S0	
6 442 003 + S0	
6 442 005 + S0	

* Worktop and legs available in a White finish only.

OPEN SIDED EASY ACCESS TABLES

+ Economical & functional



Central stem metal leg
with cruciform base



Open sided leg design
for improved accessibility

Melamine worktops
25 mm thick

4 TYPES OF TABLE DESIGN



Circular table
H. 73.5 cm



Circular table
H. 110 cm



Square table
H. 110 cm



Rectangular
table
H. 73.5 cm



Half-moon table
H. 73.5 cm



90° corner angle
H. 73.5 cm

2 EXTENSIONS



FINISHES & PRICES

Price excl. taxes: **From stock** **On request**

6

choices of melamine worktops finish (+ top)



MG
Snow white



M6
Cashmere grey



MA
White maple



R2
Honfleur beech wood



RI
Light oak



RL
Amber walnut

FROM STOCK

1

choice of metal finish for legs (+ fin.)



SA
Aluminium grey

FROM STOCK

OPEN SIDED EASY ACCESS TABLES

H. 73.5 cm



Circular tables

Ø 100 CM

6 606 006

Ø 120 CM

6 606 007

Rectangular tables.

W. 80 x D. 80 cm

6 606 001

W. 120 x D. 80 cm

6 606 002

W. 140 x D. 80 cm

6 606 003

W. 160 x D. 80 cm

6 606 004

W. 180 x D. 80 cm

6 606 005

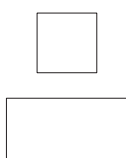

Extensions combine with rectangular tables only

90° corner angles - Non modular

W. 80 x D. 80 cm

6 606 019

Support leg Ø 60 mm

6 606 020 + SA



Half-moon - Non modular

W. 165 x D. 60 cm

6 606 009



H. 110 cm

Choice of MG and RI colour finish only.



Square table

W. 60 x D. 60 cm

6 503 006



Circular table

Ø 60 CM

6 503 010