

ZELIE, THE ANSWER TO THESE NOVEL SPACES

Discover the ZELIE lounge seats, facilitating this new way of working and welcoming visitors.

Conceived by our very own StudioDesign, ZELIE exemplifies the concept of a dynamic reception and meeting space. With an extensive palette of finishes, geometric forms, integrated charging ports and wheels, it offers practicality and a modular design that are perfectly adapted to these emerging work trends.

Modular seats

ZELIE	12
-------------	----

Easy chairs and sofas

BIP	16
-----------	----

GALWAY	20
--------------	----

CHEST	21
-------------	----

Low tables	22
------------------	----

Reception counters

GUEST	24
-------------	----

OVALI	28
-------------	----

COME IN	30
---------------	----

Bench units

EVASION/ROSALIE	34
-----------------------	----

SOSI/QUADRO	36
-------------------	----

ZELIE

ZELIE is the perfect reflection of a dynamic reception or breakout space. Its extensive palette of finishes, geometric forms, integrated charging ports and wheels all contribute to allowing the reconfiguring at will of what becomes an entirely unique space.





Dynamic & modular

1, 2 or 3 seats with or without backrest

Metal worktop with or without integrated power feeds

Freestanding metal writing shelf

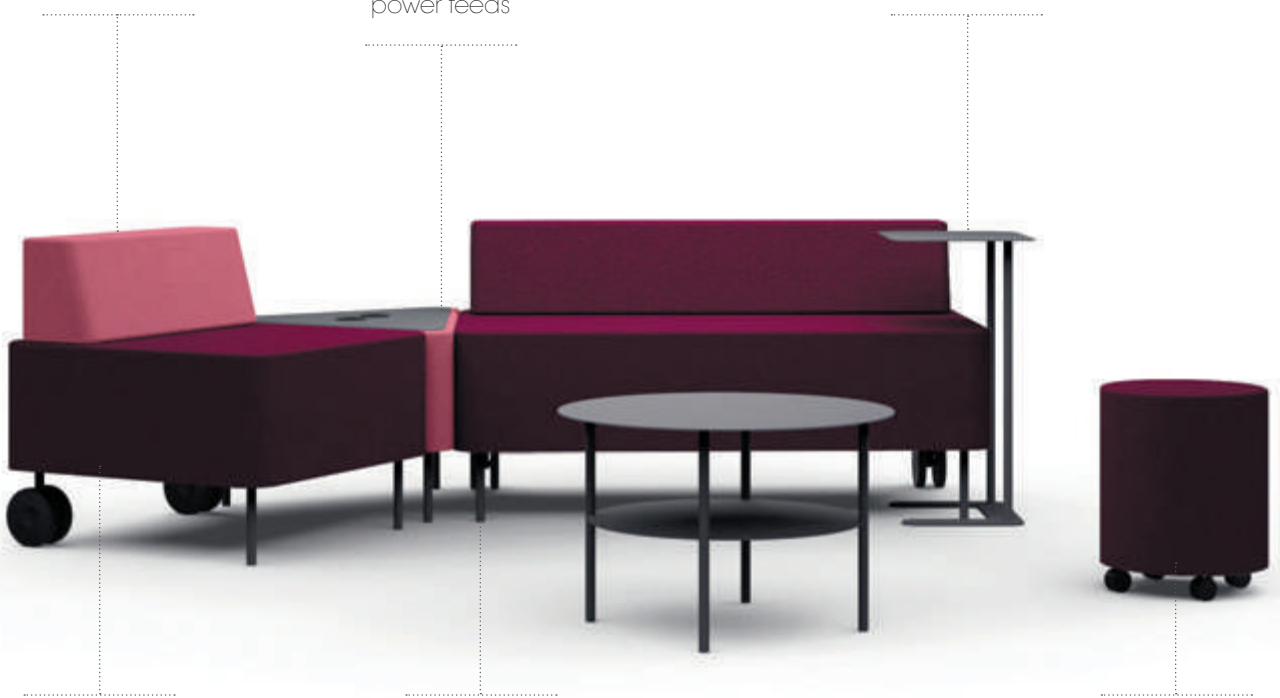

Mobile or static seat

Metal feet
Ø 20 mm

Static or mobile foot stool

3 OPTIONS



2 power outlets
on the worktop



2 wheel-mounted
rear feet



Retractable linking
system between
2 modules

FINISHES & PRICES

Price excl. taxes: **From stock** **On request**

1 single tone fabric colour (+ fab.)

Bondai (Cat. A)



KA
Storm grey

FROM STOCK

4 shade cards for fabrics



Cat. A, B, C et D
see page 283

ON REQUEST

6 two-tone colour combinations* (+ fab.)

Blazer (Cat. D)

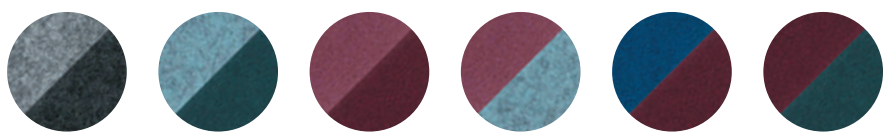

H6 J8 Medium grey Dark grey	H9 J9 Pale blue Imperial green	JG I3 Marsala rose Bordeaux	JG H9 Marsala rose Pale blue	HQ I3 Celestial blue Bordeaux	I3 J9 Bordeaux Imperial green
--	---	--	---	--	--

ON REQUEST

2 choices of metal finish for legs and tables (+ fin.)



ZO White	SC Graphite grey
--------------------	----------------------------

FROM STOCK

ON REQUEST: 4 weeks turnaround time for single tone colours and two-tone colour combinations featured above / 6 weeks for all other two-tone colour combinations.

**Interchangeable backrest/seat colour combinations. Other two-tone combinations contact us for details.*

HOW TO PLACE AN ORDER:

When ordering, in addition to the product reference include:

1. **SEAT** colour code: + **fab. 1**
2. **BACKREST** colour code: + **fab. 2**
3. **LEGS** colour code: + **fin.**





IMPORTANT TO NOTE: For seats and corner modules with worktops, the worktop comes in a matching finish to the legs. For models mounted on wheels, the colour of the wheel housing matches that of the legs; white wheel housing for white legs, black wheel housing for graphite grey legs.

14

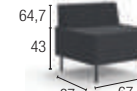

SEATS WITHOUT BACKREST	Ref. + fab. + fin.	Bondai	Xtreme CS	Ginkgo	Blazer
		(Cat. A)	(Cat. B)	(Cat. C)	(Cat. D)
		Price excl. tax			

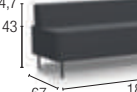
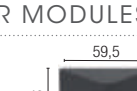
	1 seat - W. 67 cm					
	4 fixed legs	6 097 030	€ 463	€ 490	€ 529	€ 584
	2 fixed legs + 2 wheels	6 097 033	€ 551	€ 579	€ 617	€ 672
	1 seat - W. 67 cm with worktop					
	4 fixed legs	6 097 031	€ 518	€ 546	€ 584	€ 639
	2 fixed legs + 2 wheels	6 097 034	€ 607	€ 633	€ 672	€ 728
1 seat and worktop with power feed - W. 67 cm. Socket feed kit must be ordered separately (see options)						
	4 fixed legs	6 097 032	€ 518	€ 546	€ 584	€ 639
	2 fixed legs + 2 wheels	6 097 035	€ 607	€ 633	€ 672	€ 728
	2 seats - W. 120 cm					
	4 fixed legs	6 097 036	€ 656	€ 689	€ 733	€ 799
	2 fixed legs + 2 wheels	6 097 037	€ 744	€ 777	€ 821	€ 887
	3 seats - W. 180 cm					
	4 fixed legs	6 097 038	€ 854	€ 887	€ 931	€ 997
	2 fixed legs + 2 wheels	6 097 039	€ 943	€ 976	€ 1020	€ 1086

SEATS WITH BACKREST	Ref. + fab. 1 + fab. 2 + fin.	Price excl. tax			
---------------------	-------------------------------	-----------------	--	--	--

	1 seat - W. 67 cm					
	4 fixed legs	6 097 040	€ 710	€ 744	€ 794	€ 859
	2 fixed legs + 2 wheels	6 097 041	€ 799	€ 832	€ 882	€ 948
	2 seats - W. 120 cm					
	4 fixed legs	6 097 042	€ 1014	€ 1053	€ 1107	€ 1184
	2 fixed legs + 2 wheels	6 097 043	€ 1102	€ 1141	€ 1196	€ 1273
	3 seats - W. 180 cm					
	4 fixed legs	6 097 044	€ 1317	€ 1356	€ 1410	€ 1488
	2 fixed legs + 2 wheels	6 097 045	€ 1405	€ 1443	€ 1499	€ 1576

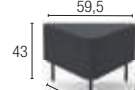
CORNER MODULES 60°	Ref. + fab. + fin.	Price excl. tax			
--------------------	--------------------	-----------------	--	--	--

	Module W. 67 cm				
	3 fixed legs	6 097 047	€ 430	€ 452	€ 474
	Module W. 67 cm with worktop				
	3 fixed legs	6 097 048	€ 463	€ 485	€ 507
	Module W. 67 cm with worktop and power feed. Electrics must be ordered separately (see options).				
	3 fixed legs	6 097 049	€ 463	€ 485	€ 507

ROUND FOOT STOOLS	Ref. + fab.	Price excl. tax			
-------------------	-------------	-----------------	--	--	--

	Ø 40 cm					
	Mounted on stabilizer feet	6 097 015	€ 204	€ 220	€ 236	€ 264
	Mounted on castors (2 are lockable)	6 097 046	€ 220	€ 236	€ 254	€ 281

TABLES	Ref. + fab.	Price excl. tax			
--------	-------------	-----------------	--	--	--

	Circular table Ø 67 cm	6 097 001	€ 215	-	-	-
	Rectangular W. 90 cm	6 097 002	€ 236	-	-	-
	Writing shelf	6 097 024	€ 138	-	-	-

OPTIONS



Interpreted worktop electrics: 1 PC power outlet + 1 twin-feed 5 V USB charger port + 1 cable outlet L. 3 m

6 097 058	€ 271	-	-	-
-----------	-------	---	---	---

Retractable linking kit. Connector elements for linking of 2 modules. Stows away under the seat when not in use.

6 097 011	€ 44	-	-	-
-----------	------	---	---	---

BIP

With different colours and leg designs to choose from such as fixed, rotating or castor-mounted, BIP easychairs are ideal for all your reception, break-out and meeting spaces. BIP's contemporary design and soft, curving lines combine with a cocoon-like seat for a unique, spacious and comfortable easy chair.





Comfortable & elegant

Contrasting topstitching
for a unique style

Over thirty different choices
of coloured fabric



5 choices of leg design
New castor-mounted leg **new**

Rounded and
enveloping lines

Fixed, castor mounted, rotating and
height-adjustable seat versions

ZOOMS



Wooden leg with
chromed metal
decorative trim



Castors for soft
or hard floors



Rounded armrest
with contrasting
topstitching

FINISHES & PRODUCT OVERVIEW

A shade card specific to the BIP range

8 choices of Evo fabric colour - Cat. A (+ fab.)

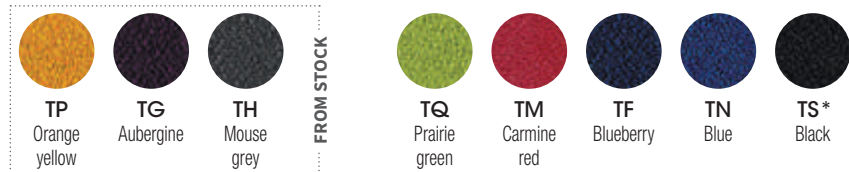

FROM STOCK

ON REQUEST

8 choices of Sofline simulated leather colour - Cat. A (+ fab.)

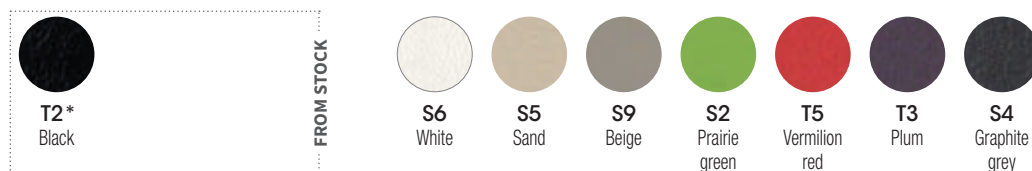

FROM STOCK

ON REQUEST

7 choices of Xtreme fabric colour - Cat. B (+ fab.)

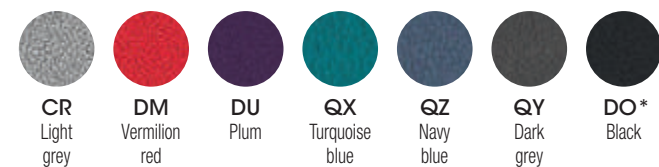

ON REQUEST

9 choices of Synergy fabric colour - Cat. C (+ fab.)

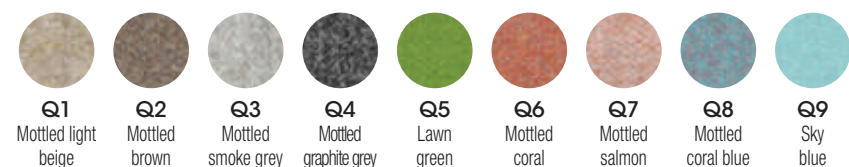

2 choices of leather colour - Cat. E (+ fab.)



ON REQUEST

* White contrasting topstitching on black coverings (TS, T2, DO, YB). Black contrasting topstitching on all other colour coverings.

ON REQUEST: allow 6 weeks

4 wooden legs⁽¹⁾

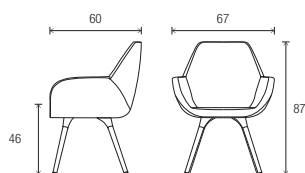

Spider leg base⁽¹⁾

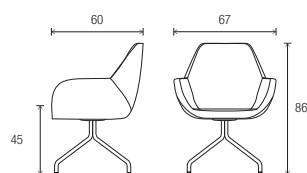

Central stem with circular base plate⁽¹⁾

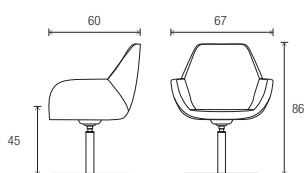

Central stem with cruciform base⁽¹⁾

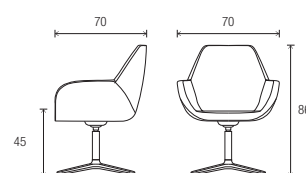

Castor-mounted legs⁽¹⁾ **new**

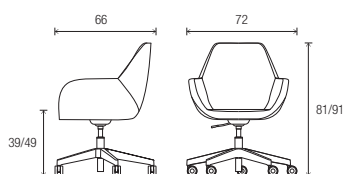

Square foot stool

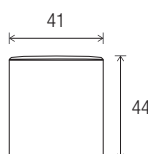



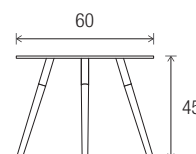

Circular low table



(1) Seat width: 43 cm, seat depth: 46 cm.

PRICES

Price excl. taxes: **From stock** **On request**

EASY CHAIRS			EVO + SOFTLINE (Cat. A)	XTREME (Cat. B)	SYNERGY (Cat. C)	LEATHER (Cat. E)
	Ref.	Price excl. tax				
Natural ash wooden legs with 4 chromed metal decorative inserts - fixed structure						
	Wooden legs 6 446 005 + fab. + MB	€ 520	€ 577	€ 629	€ 734	
Chromed tubular spider leg base - fixed structure						
	Chrome legs 6 446 003 + fab. + SQ	€ 399	€ 446	€ 509	€ 614	
Central stem with circular base plate - rotating structure						
	Chrome legs 6 446 004 + fab. + SQ	€ 535	€ 588	€ 651	€ 756	
Polished aluminium central stem cruciform base - rotating structure						
	Polished aluminium base 6 446 010 + fab. + ZF	€ 562	€ 614	€ 682	€ 792	
5 point chromed star base mounted on black ABS castors, rotating and height-adjustable structure						
	Castors for hard floors 6 446 011 + fab. + SQ	€ 520	€ 556	€ 629	€ 734	
	Castors for soft floors 6 446 012 + fab. + SQ	€ 520	€ 556	€ 629	€ 734	
SQUARE FOOT STOOL						
ABS glides - integrated linking system.						
	Square foot stool 6 447 001 + fab.	€ 199	€ 231	€ 273	€ 357	
CIRCULAR LOW TABLE						
Natural ash wooden legs with 4 chromed metal decorative inserts - frosted glass table top						
	Wooden legs 6 446 007 + GM + MB	€ 430	-	-	-	

GALWAY

Plywood internal structure

Polyurethane foam

4 square section chrome legs



SINGLE SEAT EASY CHAIR W. 70 CM

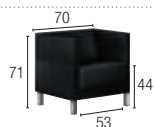

Softline simulated leather (Cat. A) Xtreme fabric (Cat. B) Leather (Cat. E)

Ref.	Price excl. tax		
------	-----------------	--	--

6 453 001 + fab. + SQ	€ 660	€ 719	€ 1117
-----------------------	-------	-------	--------

TWO SEAT SOFA W. 123 CM



6 453 002 + fab. + SQ	€ 814	€ 889	€ 1380
-----------------------	-------	-------	--------

TWO AND 1/2 SEAT SOFA W. 150 CM

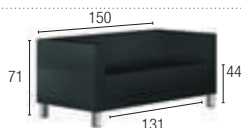

6 453 003 + fab. + SQ	€ 852	€ 1064	€ 1846
-----------------------	-------	--------	--------

A shade card specific to the GALWAY range

Price excl. taxes: **From stock** On request

8 choices of Softline simulated leather colour
Cat. A (+ fab.)

FINISHES

7 choices of Xtreme fabric colour
Cat. B (+ fab.)

2 choices of leather colour
Cat. E (+ fab.)



FROM STOCK

ON REQUEST

ON REQUEST: allow 6 weeks

CHEST

Plywood internal structure

Polyurethane foam

Fitted with 5 glides



SINGLE SEAT EASY CHAIR W. 70 CM

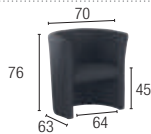

Ref.

Bondai
(Cat. A)

Simulated leather
(Cat. B)

Price excl. tax

6 409 003 + fab.

€ 367

€ 388

TWO SEAT SOFA W. 125 CM

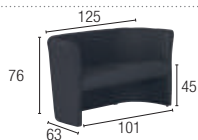

6 409 004 + fab.

€ 627

€ 659

A shade card specific to the CHEST range

Price excl. taxes: **From stock** **On request**

FINISHES

5 choices of Bondai fabric colour
Cat. A (+ fab.)

1 choice of simulated leather
colour - Cat. B (+ fab.)



KE
Black



KZ
Red



KA
Storm grey



KD
Cloud grey



K2
Navy blue



YA
Black

FROM STOCK

ON REQUEST

FROM STOCK

ON REQUEST: allow 5 weeks

BIP



Frosted glass top
Natural ash wooden legs with 4 chromed metal leg mounts

EVASION



White melamine worktop 25 mm thick
Natural ash wooden legs with white metal leg mounts

GUEST



Melamine covered table top and leg panels 38 mm thick
Panel legs

SUSHI

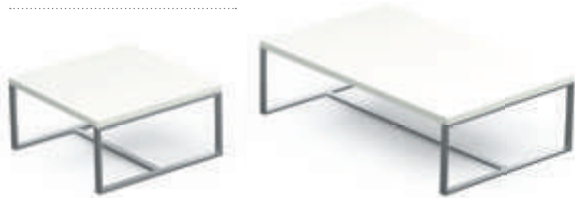

Melamine covered table top 25 mm thick
Metal legs in an Aluminium grey finish

STAR



Melamine covered table top 25 mm thick
Metal legs in an Aluminium grey finish

ZELIE



Metal table top and legs

PURE



White melamine table top 19 mm thick
Legs in a white metal finish



excluding BIP.



excluding BIP, ZELIE.

PRICES

Price excl. taxes: **From stock** **On request**

BIP		Ref.	Price excl. tax
	Circular table - H. 45 cm Ø 60 cm	6 446 007 + GM + MB	€ 430
EVASION			
	Circular table - H. 48 cm Ø 60 cm	6 634 040 + MG + ZO	€ 353
GUEST			
	Rectangular table - H. 40 x W. 110 x D. 70 cm	6 720 030 + top	€ 246
	Square table - H. 40 x W. 70 x D. 70 cm	6 720 029 + top	€ 223
SUSHI			
	Rectangular table - H. 32 x W. 110 x D. 70 cm	6 513 004 + top + SB	€ 284
	Square table - H. 32 x W. 60 x D. 60 cm	6 513 003 + top + SB	€ 226
STAR			
	Circular table - H. 45 cm Ø 75 cm	6 300 001 + top + SQ	€ 286
	Square table - H. 45 x W. 60 x D. 60 cm	6 300 002 + top + SQ	€ 217
ZELIE			
	Rectangular table - H. 43 x W. 90 x D. 50 cm	6 097 002 + fin.	€ 236
	Circular table - H. 43 cm Ø 67 cm	6 097 001 + fin.	€ 215
	Freestanding writing shelf - H. 63 x W. 32 x D. 40 cm	6 097 024 + fin.	€ 138
PURE			
	Elliptical table - H. 43 x W. 76 x D. 59 cm	6 482 001 + MG + SO	€ 198

FINISHES

STAR & SUSHI (+ top)



MG
Snow white



M6
Cashmere grey



RI
Light oak

GUEST (+ top)



MG
Snow white



RL
Amber walnut

ZELIE (+ top)



ZO
Textured white



SC
Graphite grey

FROM STOCK

GUEST

The GUEST range of reception counters is ultra-customisable thanks to its variety of modules, finishes and extensive choice of colours and optional complements. It will allow you to create a unique reception space that truly reflects the identity of your company.



- Modular seats, page 12
- Lockers, page 131
- Ergonomic chairs, page 195



Modular & customisable

Counter-top shelf with
«welcome» or «bienvenue»
lettering, or neutral

Melamine worktops 38 mm thick
Melamine cladding 19 mm thick

or metal cladding **new**



White melamine
structure and white
counter base

Full counter-depth legs at the extremities
and space saving intermediary legs
facilitating mobility between modules
(with height-adjustable feet)

POWER AND CABLE MANAGEMENT

2 OPTIONS



Worktops fitted
with 2 cable ports
(except DDA
modules)



LED backlight
(white or colour
changing)



Metal cable
trough for cable
and wire routing

FINISHES & PRODUCT OVERVIEW

2 choices of melamine worktop (+ top 1)

5 choices of melamine cladding (+ top 2)

7 choices of metal cladding finish (+ fin.)**

FROM STOCK

ON REQUEST

MG Snow white

RL* Amber walnut

M2 Green

M4 Yellow

M1 Cherry red

SO White

SA Aluminium grey

SG Black

SC Graphite grey

X3 Emerald green

X5 Sunflower yellow

X6 Carmine red

ON REQUEST: allow 6 weeks

*Exclusively paired with Amber walnut finish melamine cladding.
 ** Metal cladding: paired exclusively with white worktops.

High standard modules

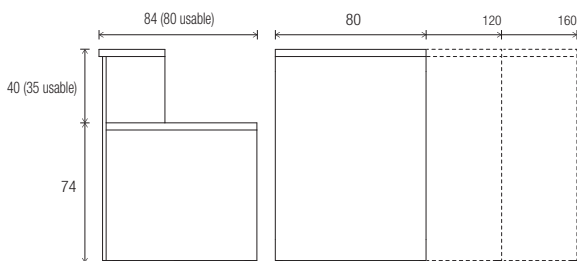

Corner modules

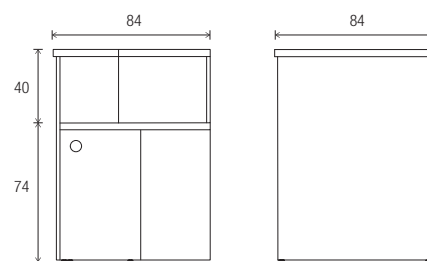

Low DDA module***

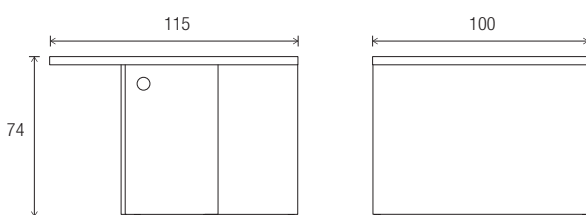

Low offset DDA module***

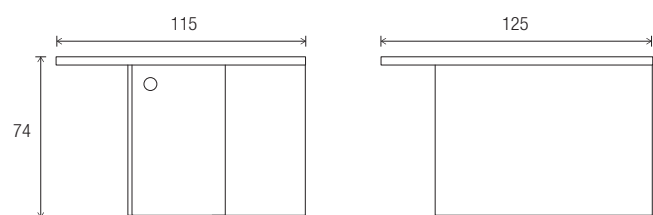

*** DDA: Disability Discrimination Act compliant

PRICES

Price excl. taxes: **From stock** **On request**

new

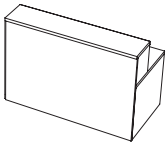
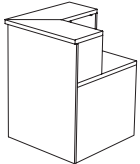
HIGH STANDARD MODULES H. 113 CM			Melamine cladding		Metal cladding	
			Ref. + top 2 + top 1	Price excl. tax	Ref. + fin. + MG P	Price excl. tax
	W. 80 cm	Free-standing	6 720 160	€ 722	6 720 133	€ 786
		Intermediary unit	6 720 161	€ 607	6 720 134	€ 671
		Left-hand corner module	6 720 162	€ 662	6 720 135	€ 727
		Right-hand corner module	6 720 163	€ 662	6 720 136	€ 727
	W. 120 cm	Free-standing	6 720 164	€ 819	6 720 137	€ 898
		Intermediary unit	6 720 165	€ 716	6 720 138	€ 795
		Left-hand corner module	6 720 166	€ 764	6 720 139	€ 843
		Right-hand corner module	6 720 167	€ 764	6 720 140	€ 843
	W. 160 cm	Free-standing	6 720 168	€ 941	6 720 141	€ 1037
		Intermediary unit	6 720 169	€ 837	6 720 142	€ 933
		Left-hand corner module	6 720 170	€ 885	6 720 143	€ 981
		Right-hand corner module	6 720 171	€ 885	6 720 144	€ 981
	90° left-hand corner module	Intermediary unit	6 720 172	€ 776	6 720 145	€ 941
		Right-hand corner module	6 720 173	€ 788	6 720 146	€ 952
	90° right-hand corner module	Intermediary unit	6 720 174	€ 776	6 720 147	€ 941
		Right-hand corner module	6 720 175	€ 788	6 720 148	€ 952

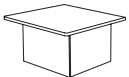
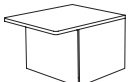
LOW MODULES H. 74 CM			Ref. + top 2 + top 1	Price excl. tax	Ref. + fin. + MG	Price excl. tax
	DDA W. 100 cm	Intermediary unit	6 720 176	€ 595	6 720 156	€ 649
		Left-hand corner module	6 720 177	€ 651	6 720 157	€ 705
		Right-hand corner module	6 720 178	€ 651	6 720 158	€ 705
	DDA W. 125 cm (offset worktop)	Left-hand corner module	6 720 179	€ 661	6 720 149	€ 751
		Right-hand corner module	6 720 180	€ 661	6 720 150	€ 751

OPTIONS		Ref. + fin.	Price excl. tax
Counter-top shelf W. 100 cm	Neutral version	6 720 026	€ 152
	With "Welcome" lettering	6 720 425	€ 236
	With "Bienvenue" lettering	6 720 424	€ 236
	Customised version	For product references and pricing: contact us	
LED backlight kit - Attaches to the lower section of the counter-top shelf or behind the lettering			
	White LED kit	6 720 056	€ 129
	LED kit with light colour changer	6 720 055	€ 246
Cable trough	Cable trough W. 70 cm	6 010 001	€ 39

 **Power and cable management**
Optional - see page 273

Descriptions of left and right-hand side are determined in relation to the position of the user.

OVALI

+ Convivial & compact

Toughened glass top 8 mm thick with a satin finish



Melamine covered worktop
28 mm thick

Legs with
height-adjustable feet

2 MODULES



Left-hand module



Right-hand module



Storage unit with
2 shelves, 1 of which
is removable



FINISHES

2 choices of melamine finish (+ top)



NAMZ
Pastel white/Light walnut



NANE
Pastel white/Wenge

FROM STOCK

DIMENSIONS

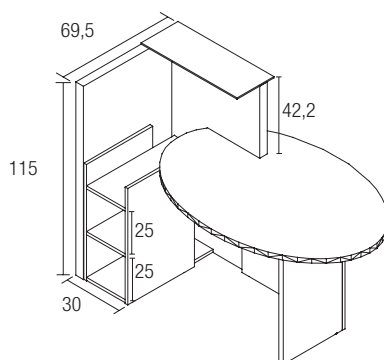
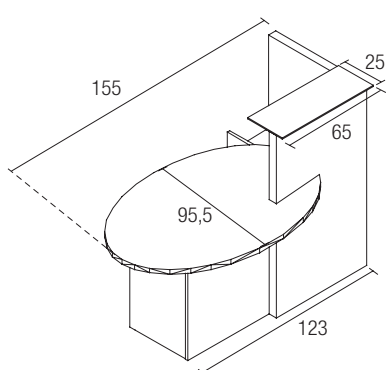

PRICES

Price excl. taxes: **From stock** **On request**

FREE-STANDING MODULES

Left-hand module

6 632 012 + top

Price excl. tax

€ 1218

Right-hand module

6 632 011 + top

€ 1218

COME IN

By allowing the combination of different free-standing modules, COME IN reception counters adapt seamlessly to your reception space. The customisable finish for the corner angle module provides an opportunity for an added personal and creative touch.

+ Classic & versatile



FINISHES & PRODUCT OVERVIEW

2

choices of melamine worktop (+ top)

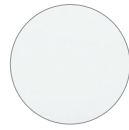

NA
Pastel white



NB
Natural beech

FROM STOCK

3

choices of melamine finish for the corner module modesty panel (+ fin.)



NA
Pastel white



MH
Aluminium grey



RN
Red

FROM STOCK

PRICES

Price excl. taxes: **From stock** **On request**

HIGH STANDARD MODULES H. 111 CM

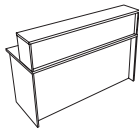

Standard modules

W. 80 cm x D. 70 cm

6 735 051 + top

Price excl. tax

€ 494

W. 120 cm x D. 70 cm

6 735 047 + top

€ 517

W. 160 cm x D. 70 cm

6 735 049 + top

€ 594

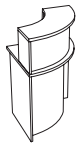

90° corner modules

White

6 735 045 + NA NA

€ 847

Grey

6 735 045 + NA MH or NB MH

€ 770

Red

6 735 045 + NA RN

€ 847

LOW MODULES H. 75.8 CM

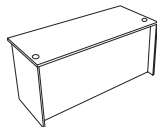

Standard modules

W. 80 cm x D. 70 cm

6 735 052 + top

Price excl. tax

€ 307

W. 120 cm x D. 70 cm

6 735 048 + top

€ 330

W. 160 cm x D. 70 cm

6 735 050 + top

€ 396

W. 120 cm x D. 70 cm DDA*

6 735 044 + top

€ 384

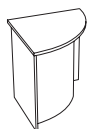

90° corner modules

White

6 735 046 + NA NA

€ 605

Grey

6 735 046 + NA MH or NB MH

€ 550

Red

6 735 046 + NA RN

€ 605

* DDA: Disability Discrimination Act compliant

EVASION

A contemporary design applied to beech plywood seats, for a warm and modern welcome



Brushed aluminium base

Positioning of seats and magazine shelf can be personalised

Seat set forward in relation to the rear leg (to avoid scuffing the wall)

- EVASION low table, page 22
- Multi-purpose EVASION tables, page 186
- EVASION chairs, page 236



BENCH WITHOUT SHELF

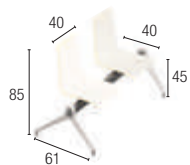

- 2 seats - W. 128 cm
- 3 seats - W. 190 cm
- 4 seats - W. 199.8 cm offset seats

Ref. + col. + fin.	Black crossbeam	Aluminium crossbeam
	Price excl. tax	Price excl. tax
6 634 045	€ 584	€ 607
6 634 047	€ 749	€ 771
6 634 049	€ 892	€ 915

BENCH WITH SHELF

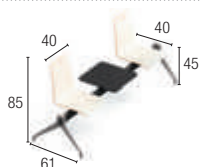

- 2 seats - W. 190 cm
- 3 seats - W. 199.8 cm offset seats

6 634 046	€ 705	€ 728
6 634 048	€ 859	€ 882

FINISHES

2 choices of beech plywood seats colour (+ col.)



VK
White



VM
Black

2 choices of finish for metal crossbeams (+ fin.)



SB
Aluminium grey



SG
Black

FROM STOCK

ROSALIE

4 choices of colour finish for a colourful reception style

Comfortable and enveloping seat

Easy-clean seat shell (polypropylene)



ROSALIE chair, page 244



BENCH WITHOUT SHELF



2 seats - W. 128 cm
3 seats - W. 190 cm
4 seats - W. 222 cm offset seats

Ref. + col. + fin.	Black crossbeam	Aluminium crossbeam
	Price excl. tax	Price excl. tax
5 620 030	€ 428	€ 449
5 620 032	€ 535	€ 556
5 620 034	€ 621	€ 642

BENCH WITH SHELF



2 seats - W. 190 cm
3 seats - W. 222 cm offset seats

5 620 031	€ 556	€ 578
5 620 033	€ 642	€ 663

* Seat with cushion pad available on request (contact us for details).

FINISHES

4 choices of polypropylene seat colour (+ col.)



2 choices of finish for metal crossbeams (+ fin.)

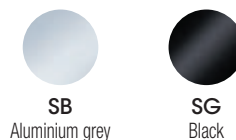

FROM STOCK

ON REQUEST

FROM STOCK

ON REQUEST: allow 4 weeks

SOSI

Easy-clean and hard-wearing seat shell (metal seat and backrest)

Bench unit available with or without magazine shelf



Positioning of seats and magazine shelf can be personalised

Fixings for securing to the floor available on request (contact us for details)



BENCH WITHOUT SHELF

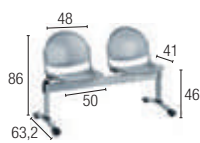

- 2 seats - W. 128 cm
- 3 seats - W. 190 cm
- 4 seats - W. 216 cm offset seats

Ref.	Black crossbeam	Aluminium crossbeam
	Price excl. tax	Price excl. tax
6 490 003 + fin.	€ 382	€ 440
6 490 005 + fin.	€ 515	€ 591
6 490 007 + fin.	€ 688	€ 793

FINISHES



SB
Aluminium grey



SG
Black

FROM STOCK

BENCH WITH SHELF

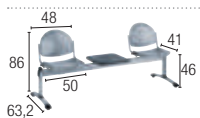

- 2 seats - W. 190 cm
- 3 seats - W. 216 cm offset seats

6 490 002 + fin.	€ 509	€ 567
6 490 004 + fin.	€ 642	€ 718

QUADRO

Easy-clean
and hard-wearing seat shell
(metal seat and backrest)

Positioning of seats and magazine
shelf can be personalised

Bench unit available with
or without magazine shelf



Fixings for securing
to the floor available on request
(contact us for details)



BENCH WITHOUT SHELF



2 seats - W. 128 cm

3 seats - W. 190 cm

Aluminium crossbeam

Ref.	Price excl. tax
6 820 002 + SB	€ 550
6 820 004 + SB	€ 752

FINISHES



SB
Aluminium grey

FROM STOCK

BENCH WITH SHELF

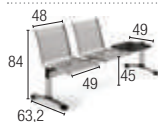

2 seats - W. 190 cm

6 820 001 + SB

€ 689