

PEDRALI S.p.A.

sp 122 Mornico al Serio - 24050 BERGAMO - ITALY
Export Dept. Tel: +39 035 8358840 Fax +39 035 8358888
Ufficio Commerciale Italia Tel: +39 035 8358810 Fax +39 035 8358888

www.pedrali.it - info@pedrali.it

PEDRALI[®]
DYNAMIC DESIGN

TOUCHSOFT 2015

SEDUTE E PANCHE

TOUCHSOFT_1502

PEDRALI

TOUCHSOFT 2015

SUBLITZ AGLISS AZMIES AZIPPOWOWH ESTER PRO LAJA
END SOFT ISLAND JAGS HOST M KUADRAXL SHOS UBTREND N LOG
RACE X JOKER LAGS GRACE X ZIPPO SHOX I MODUS
A ESTER C KUADRA S ZIGL LAJA HOST C ISLAND SHOX I LAJAMYA
BRACCOFF M JOKER I BRACCOFF M JOKER I BRACCOFF M JOKER I

TOUCH**SOFT** 2015

Blitz Soft p. 66

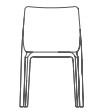

Kuadra XL Cuoio p. 80

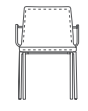

Soft p. 74

UPDATE Ester p. 14



UPDATE Laja p. 20



Gliss Cuoio p. 52



Leila p. 62



Soft p. 56

Gliss Lounge Cuoio p. 48



NEW Log p. 04



Soft p. 50

UPDATE Gliss Wood p. 46



Mies p. 124



Grace Soft p. 60



Modus p. 96

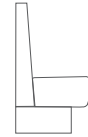

Host p. 110

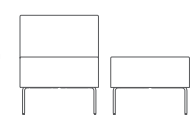

Mood p. 70



Host Lounge p. 118

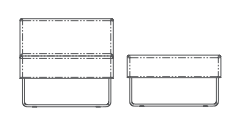

Mya Soft p. 92



NEW Inga Soft p. 42



UPDATE Noa p. 34



Island p. 132



Trend Cuoio p. 90



Joker p. 128



Wow p. 122



Kuadra Cuoio p. 86

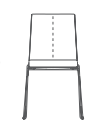

NEW Zippo p. 08

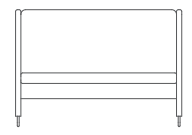

Soft p. 82

04 Log

Design Manuela Busetti, Andrea Garuti, Matteo Redoelli

Art. 365

Log è una sedia completamente imbottita, costituita da un unico volume compatto nel quale è ricavata una comoda seduta che avvolge leggermente il corpo, senza intralciare i movimenti.
Log is a fully upholstered one-volume-seating that welcomes the body gently, without hindering movements.

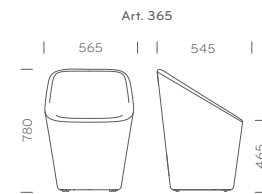

Rivestimento disponibile: categoria C, G, da H20 a H35, da H80 a H90
Covering available: category C, G, from H20 to H35, from H80 to H90



Art. 365

Grazie all'utilizzo delle migliori tecnologie per gli imbottiti, Log riesce a contenere al massimo il suo peso. La struttura in acciaio è immerso in schiuma di poliuretano espanso.
Using the best upholstery technologies the weight of Log has been minimized.
The steel structure is covered by polyurethane foam.



Art. ZIP2P/100 - ZIP2P/140

Zippo è un divanetto imbottito pensato per gli ambienti ufficio e contract e caratterizzato da linee pulite ed essenziali. Una nicchia di privacy per isolarsi dall'ambiente circostante, un luogo perfetto per tenere una riunione, lavorare al pc o parlare al telefono. L'altezza e la conformazione dei fianchi e dello schienale garantiscono un'ottima capacità fonoassorbente, l'anima della seduta in poliuretano ignifugo a densità variabile e l'inclinazione dello schienale offrono un comfort assoluto.

Zippo is an upholstered sofa conceived for office and contract environments, featured by essential and fairly lines. A niche of privacy where being isolated from the surroundings, a perfect place for a meeting, working on computer or talking on the phone. The height and structure of side and back guarantee a good soundproof capacity. The seat, made of fire retardant polyurethane foam with variable density and the slope backrest offer an extreme comfort.

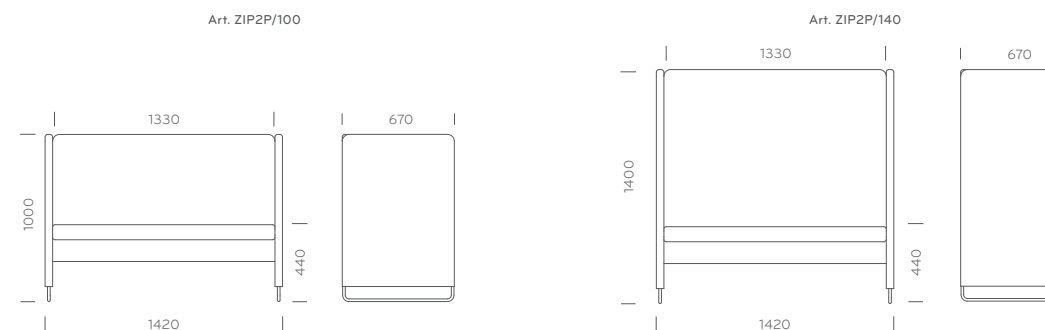

Rivestimento disponibile: categoria A, C, G, H
Covering available: category A, C, G, H

Coefficiente assorbimento acustico: 100 Hz=1,46 (EN ISO 354:2003)
Sound absorption measurement: 100 Hz=1,46 (EN ISO 354:2003)



ZIP2P/100



ZIP2P/140



12 Zippo

Art. ZIP1P/100 - ZIP1P/140

Zippo è un divanetto imbottito a uno o due posti. Lungo il perimetro corre una zip che ne delinea le forme, tanto da definirne il nome. Può essere rivestito in tessuto o finta pelle. Il telaio è in tubo d'acciaio Ø16 mm verniciato bianco, nero o alluminio, in tinta col colore della zip.

Zippo is a one or two seats upholstered sofa. Along the perimeter runs a zip that outlines its forms, so as to define its name. It can be covered with fabric or simil leather. Steel tube frame Ø16 mm is white, black or aluminium powder coated and matched with the zip colour.

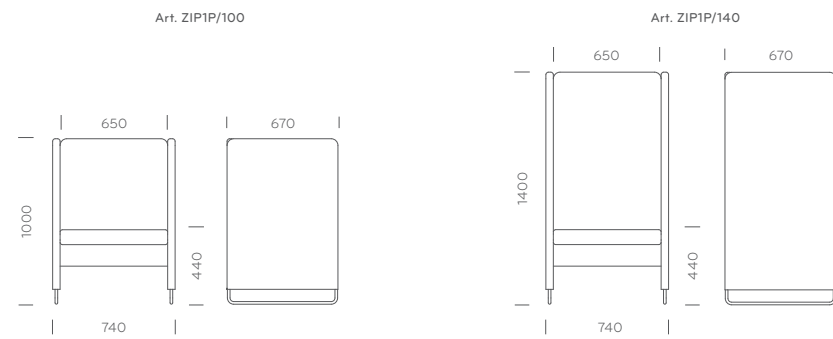

Rivestimento disponibile: categoria A, C, G, H
Covering available: category A, C, G, H

Coefficiente assorbimento acustico: 100 Hz=1,46 (EN ISO 354:2003)
Sound absorption measurement: 100 Hz=1,46 (EN ISO 354:2003)



ZIP1P/100



Design Patrick Jouin

Art. 690

La poltrona Ester è un mix di eleganza, ergonomia e funzionalità. L'attenzione per il dettaglio è onnipresente. Il risultato è un prezioso monolito di pelle, completato dalla raffinata gamba in pressofusione d'alluminio.

Ester armchair is a mix of elegance, ergonomics and functionality. The attention to details is everywhere. The result is a precious monolith made of leather complemented by refined die-casted aluminum legs.



Art. 690 - 691

Sedia e poltrona Ester hanno seduta in schiumato poliuretano con cinghie elastiche su struttura in acciaio, rivestimento in pelle o tessuto. Gambe in pressofusione di alluminio nelle finiture: nichel satinato, bronzo satinato o nichel nero.
 Ester chair and armchair have seat made of polyurethane foam with elastic belts on a steel structure, upholstery in real leather or fabric. Die-casted aluminium legs, finishes: brushed nickel, brushed bronze or black nickel.

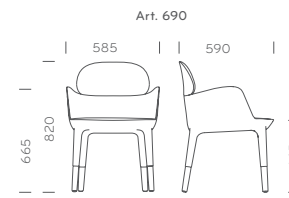

Rivestimento disponibile: categoria da G01 a G10, da G59 a G75, da H20 a H35, da H80 a H90,P
 Covering available: category from G01 to G10, from G59 to G75, from H20 to H35, from H80 to H90,P

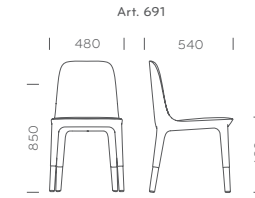

Rivestimento disponibile: categoria da G01 a G10, da G59 a G75, da H20 a H35, da H80 a H90,P
 Covering available: category from G01 to G10, from G59 to G75, from H20 to H35, from H80 to H90,P

Finiture: / Finishes:

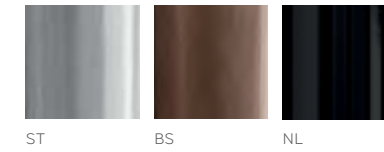

690



691



Art. 695 - 696 - 695F - 696F

La poltrona Ester allarga i suoi orizzonti per portare eleganza e comfort negli ambienti office. La base centrale a quattro razze, con ruote e senza ruote, rende Ester Office ideale per gli uffici direzionali e le sale riunioni.

Le sue forme sinuose e morbide rivestite in pelle o tessuto garantiscono il massimo comfort. La seduta, i fianchi e lo schienale sono realizzati in schiumato poliuretano con cinghie elastiche su struttura in acciaio.

Ester armchair widens its horizons bringing elegance and comfort to offices. The central four-spoke base, with or without castors, makes Ester Office ideal for executive offices and meeting rooms. Its sinuous and soft upholstered in leather or fabric ensure maximum comfort. The seat, the sides and the backrest are made of polyurethane foam with elastic belts on a steel structure.

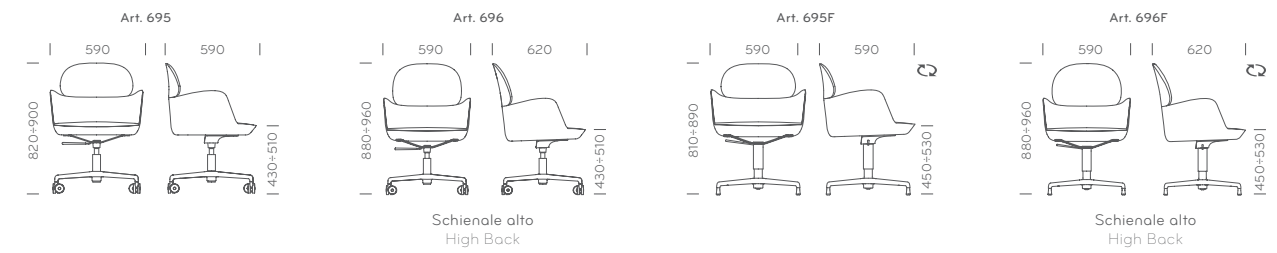

Rivestimento disponibile: categoria da G01 a G10, da G59 a G75, da H20 a H35, da H80 a H90, P
 Covering available: category from G01 to G10, from G59 to G75, from H20 to H35, from H80 to H90, P



695F



695



696

Art. 880 - 881 - 885 - 886 - 887

La famiglia Laja è composta da sedia e poltrona con 4 gambe in pressofusione di alluminio, poltrona con base centrale a 4 razze con e senza ruote, poltrona con telaio a slitta in tondino d'acciaio. Diversi modelli per diversi contesti di utilizzo.
Laja family consists of chair and armchair with 4 die-casted aluminium legs, armchair with 4 feet die-casted aluminium base with or without castors, armchair with steel rod sled frame. Different versions, suitable for different environments.

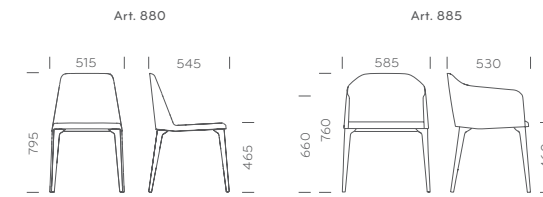

Rivestimento disponibile: categoria A, C, G, H, P
Covering available: category A, C, G, H, P

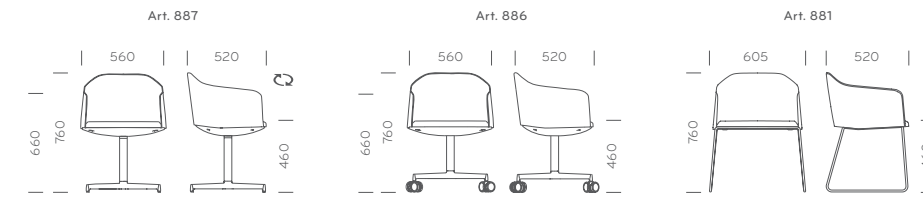

Rivestimento disponibile: categoria A, C, G, H, P
Covering available: category A, C, G, H, P



880



885



887



886

Art. 880 - 885

Segno pulito e cura dei dettagli per Laja, soluzione versatile per gli ambienti contract più raffinati. La seduta è formata da cinghie elastiche incrociate e immersa in una schiuma di poliuretano espanso. Lo schienale è leggermente elastico ed accogliente. Clear sign and care of details for Laja, ideal solution for the most refined contract environments. The comfortable seat is made of crossed elastic belts, covered by polyurethane foam. The back is slightly elastic and comfortable.

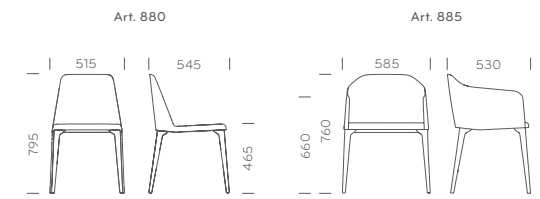

Rivestimento disponibile: categoria A, C, G, H, P
Covering available: category A, C, G, H, P



885



Art. 886 - 887

Laja poltrona con base a 4 razze in pressofusione di alluminio verniciata bianca e nero oppure proposta nella finitura lucida. Nella versione con piedini fissi ha scocca girevole con meccanismo di ritorno automatico.
 Laja armchair with 4 feet die-casted aluminium base, white and black powder coated or polished finish. Swivel seat with automatic return device for version with fixed feet.

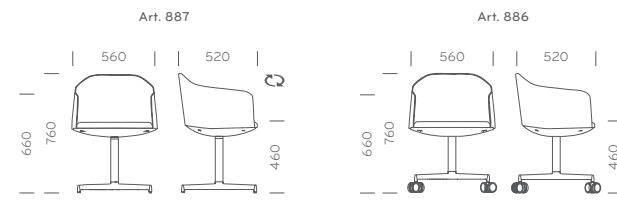

Rivestimento disponibile: categoria A, C, G, H, P
 Covering available: category A, C, G, H, P



886



Art. 887 - Poltrone Laja e basamento Laja (Art. 5430) verniciato bianco con ripiano in stratificato Compact Full Colour.
 Laja armchairs and Laja table base (Art. 5430) in white powder coated finish with Compact Full Colour solid laminate top.



Art. 885 - Poltrone Laja e tavolo Arki-Table con canalina (Art. ARK300X120CC).
Laja armchairs and Arki-Table with cable management (Art. ARK300X120CC).

Art. 882

Laja Cantilever è una reinterpretazione delle sedute d'attesa utilizzate negli ambienti ufficio. Il telaio a sbalzo garantisce una leggera flessione dello seduto rendendolo confortevole ed ergonomica, donandole un aspetto slanciato.
Laja Cantilever is flexible and ergonomic, a smart re-interpretation of the office guest chairs. The compact and elegant shell is made of a steel frame covered by polyurethane foam.

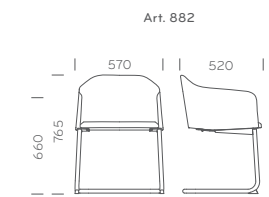

Rivestimento disponibile: categoria A, C, G, H, P
Covering available: category A, C, G, H, P



882

Art. 889G - 889F

Laja Wings è disegnata per gli ambienti ufficio e la casa. I dettagli sartoriali dell'imbottitura sono impreziositi da combinazioni di pelle e tessuto, che prendono ispirazione dal mondo della moda. Composta da una struttura in acciaio immersa in schiuma di poliuretano espanso. Nella parte anteriore dei fianchi sono inserite due piccole ruote che agevolano la movimentazione lineare della poltrona. Disponibile la versione con ruote piroettanti a garantire completa mobilità.

Laja Wings is designed for exclusive home and office contexts. The sartorial upholstery details are enriched by a mix of leather and fabric, inspired by fashion trends. Two small wheels are inserted in the front part of the sides, enable the linear motion of the chair. The version with swiveling wheels offers complete mobility.

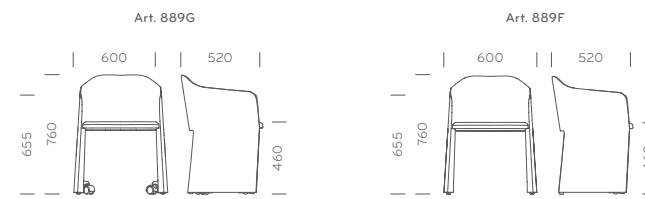

Rivestimento disponibile: categoria A, C, G, H, P
Covering available: category A, C, G, H, P



889G



889F





Art. 880 - Sedie Laja e tavolo Togo con ripiano in stratificato quadrato 1390x1390 mm nella versione monocromatica bianca.
Laja chairs and Togo table with 1390x1390 mm solid laminate top in white full colour version.

Art. 880

Linee continue e pulizia formale per Laja versione sedia. La vasta gamma di rivestimenti della scocca permette di realizzare abbinamenti bicromatici interno/esterno.
Continuous lines and clear shapes for Laja chair. The wide range of fabrics allows bichromatic combinations inside/outside for upholstered shell.

Art. 880

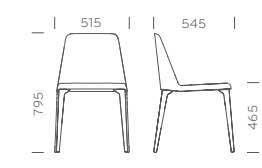

Rivestimento disponibile: categoria A, C, G, H, P
Covering available: category A, C, G, H, P



Design Marc Sadler



Art. 725

Noa unisce l'eleganza delle sue perfette proporzioni al comfort della seduta, il tutto grazie all'innovativa tecnica costruttiva. La seduta è imbottita ed è contenuta in una scocca in policarbonato la cui superficie esterna è lucida.

Noa combines the elegance of its perfect proportions to the comfort of the seat, all thanks to the innovative construction technique. The seat is upholstered and contained in a polycarbonate shell with a glossy outer surface.

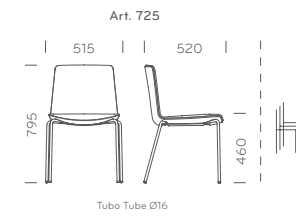

Colori scocca / Shell colours:



Categorie rivestimenti disponibili: da C50 a C57, G, H
Covering categories available: from C50 to C57, G, H





Art. 725

Noa è impilabile. Le gambe possono essere in acciaio cromato oppure verniciato in tinta con la scocca in policarbonato nero o bianco.

Noa is stackable. The legs are chromed or powder coated in the same colour of the polycarbonate shell, black or white.





Art. 727 - 727/2

Sedia Noa con base a 4 razze in pressofusione di alluminio, munita di ruote oppure con piedini fissi. Lo gamma dei rivestimenti della seduta in tessuto o ecopelle, in combinazione con i colori della scocca offre una vasta scelta di possibili personalizzazioni e soluzioni arredative sia contract che office e residential.

Noa chair 4 feet die-casted aluminium base on castors or with fixed feet also available. The upholstery range of fabric or eco-leather for the seat in combination with the colours of the shell offers a wide range of possible customizations and solutions for contract, office and residential furnishings.

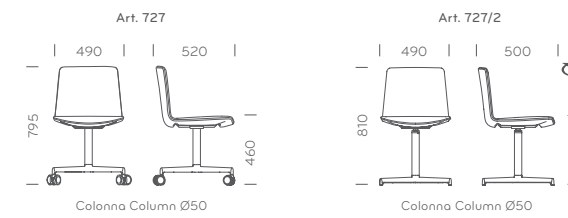

Categorie rivestimenti disponibili: da C50 a C57, G, H
Covering categories available: from C50 to C57, G, H

Colori scocca / Shell colours:

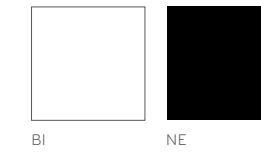

727



727/2

40 Noa

Art. 726 - 728 - 728/2

Design minimale e studiato nei particolari per Noa versione poltrona. Il bracciolo ha finitura lucida ed è in tinta con la scocca bianca o nera. Noa poltrona è impilabile. Disponibile anche nella versione con base a 4 razze, con e senza ruote, in pressofusione di alluminio verniciato bianco e nero oppure finitura lucida.

Minimal and detailed design for Noa armchair version. The armrest has the same glossy finish of the white or black shell. Noa armchair is stackable. 4 feet die-casted aluminium base with or without castors also available, white and black powder coated or polished finish.

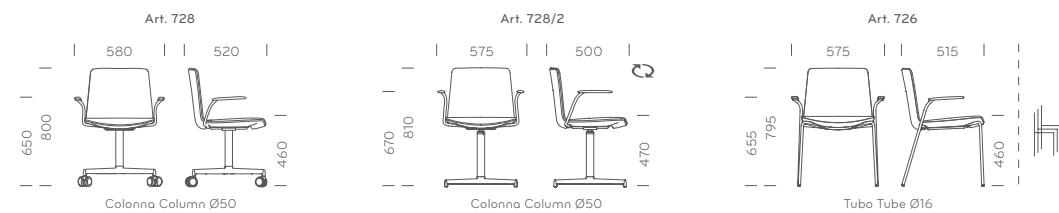

Categorie rivestimenti disponibili: da C50 a C57, G, H
Covering categories available: from C50 to C57, G, H

Colori scocca / Shell colours:

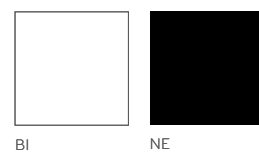

726



Design Pedrali R&D

Art.5683 - 5687

Inga è caratterizzata da linee morbide ed essenziali. La sedia e lo sgabello, disponibile in due altezze, hanno telaio in tubo d'acciaio Ø 16 mm e la scocca imbottita rivestita in tessuto o finta pelle. La sedia, impilabile grazie all'applicazione di un pannello sotto la scocca a richiesta, è disponibile anche con telaio in tondino d'acciaio Ø 11 mm e scocca in cuoio naturale o rigenerato.

Inga is featured by soft and essential shapes. Chair and stool, available in two heights, have Ø 16 mm steel tube frame and upholstered shell covered with fabric or simil leather. The chair, stackable thanks to a special optional panel applied under the shell, is available also with Ø11 mm steel rod frame and shell covered with genuine or regenerated leather.

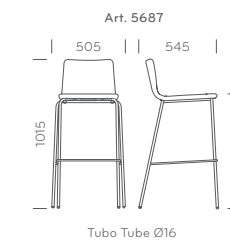
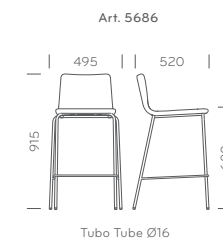
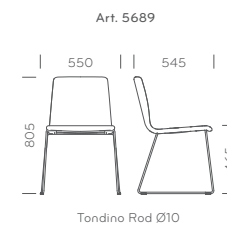
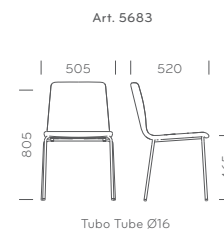

Categorie rivestimenti disponibili: A, C, G, H
Covering categories available: A, C, G, H



5683



5687



Art.5684 - 5685

Poltrona Inga ha telaio in tubo d'acciaio Ø 16 mm e scocca imbottita rivestita in tessuto o finta pelle. Disponibile la versione con braccioli imbottiti e la versione con scocca in cuoio naturale o rigenerato. Impilabile grazie all'applicazione di un pannello sotto la scocca a richiesta.

Inga armchair has Ø 16 mm steel tube frame and upholstered shell, covered with fabric or simil leather. Upholstered armrests version and genuine or regenerated shell version also available. Stackable thanks to a special optional panel applied under the shell.

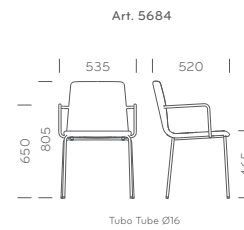

Art. 5684

Tubo Tube Ø16

Categorie rivestimenti disponibili: A, C, G, H
Covering categories available: A, C, G, H

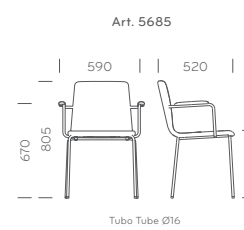

Art. 5685

Tubo Tube Ø16



5684



5685

46 Gliss Wood

Design Claudio Dondoli and Marco Poggi

Art. 904/F - 900.8

Gliss Wood può avere scocca rivestita in cuoio naturale oppure in tecnopolimero accessoriabile con imbottitura sfoderabile che rende la seduta ancora più confortevole e avvolgente. Gambe in frassino sbiancato o tinto nero.

Gliss Wood, upholstered shell in genuine leather or upholstered removable stuffing to be applied on the technopolymer shell to make the seat more comfortable and snugging. Bleached or black stained ash timber legs.

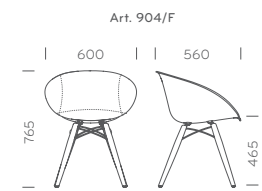

Categoria rivestimenti disponibili: F01, F03, F04, F05, F06, F07, F08, F09
Covering category available: F01, F03, F04, F05, F06, F07, F08, F09

Finiture: / Finishes:

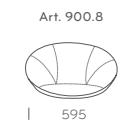

904/F09



904+900.8

48 Gliss Lounge Cuoio

Design Claudio Dondoli and Marco Poggi

Art. 341

La sedia Gliss Lounge è dedicata a chi vuole rilassarsi senza rinunciare alla funzionalità e all'eleganza. Scocca rivestita in cuoio naturale e telaio a slitta in tondino d'acciaio. Disponibile la versione con base centrale a 4 razze in pressofusione di alluminio (Art. 361).

Gliss Lounge chair is dedicated to those who want to relax without renouncing at functionality and elegance. Shell upholstered with genuine leather and sled frame in steel rod frame. Die-casted aluminium central base with 4 feet available (Art. 361).

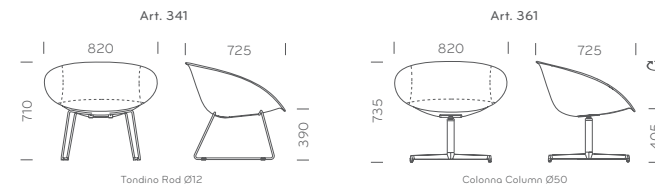

Categoria rivestimenti disponibili: F01, F03, F04, F05, F06, F07, F08, F09
Covering category available: F01, F03, F04, F05, F06, F07, F08, F09

Art. 351

Gliss Swing è la versione a dondolo con scocca rivestita in cuoio naturale e telaio in tondino su cui sono montati i due pattini in essenza di frassino.

Gliss Swing rocking chair with shell upholstered in genuine leather. Two blocks in ash wood are assembled on the steel rod frame.

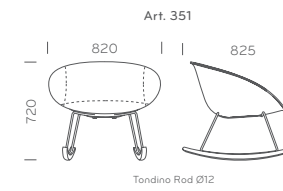

Categoria rivestimenti disponibili: F01, F03, F04, F05, F06, F07, F08, F09
Covering category available: F01, F03, F04, F05, F06, F07, F08, F09

Gliss Swing Cuoio 49



341/F09



351/F05

50 Gliss Lounge Soft

Design Claudio Dondoli and Marco Poggi

Art. 340/3

L'imbottitura sfoderabile applicabile alla scocca in tecnopolimero Gliss Lounge rende la seduta ancora più confortevole ed avvolgente.
The technopolymer shell of Gliss Lounge can be upholstered with a removable cover that makes the seat more comfortable and snugging.

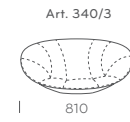

Categoria rivestimenti disponibili: A, C, G, H
Covering category available: A, C, G, H



Design Claudio Dondoli and Marco Poggi

Art. 930 - 936

Sedia Gliss rivestita in cuoio naturale con telaio in tondino d'acciaio cromato Ø 10 mm; disponibile la versione sgabello.
 Gliss chair covered with genuine leather with clear stitches.
 Ø 10 mm chromed steel rod frame. Bar stool versions available.

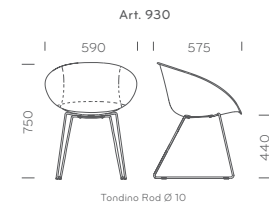

Categoria rivestimenti disponibili: F01, F03, F04, F05, F06, F07, F08, F09
 Covering category available: F01, F03, F04, F05, F06, F07, F08, F09

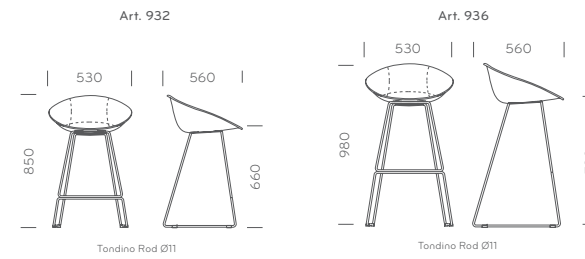

Categoria rivestimenti disponibili: F01, F03, F04, F05, F06, F07, F08, F09
 Covering category available: F01, F03, F04, F05, F06, F07, F08, F09



930/F06



936/F04





Tavolo Matrix Desk Art. TMS_350X160. Gambe in alluminio anodizzato, top in laminato bianco.
Matrix Desk table Art.TMS_350X160. Anodized aluminium legs, white laminate top.

Art. 950/F - 966/F

Gliss in cuoio su base centrale girevole con alzata a gas. Base in acciaio inox lucidato e colonna cromata (Art. 950/F). Gliss con base a cinque razze in alluminio lucidato con ruote adatte per pavimenti in legno (Art. 966/F).
Gliss covered with genuine leather with swivel central base and gas lift device. Polished stainless steel base and chromed column (Art. 950/F). Gliss polished aluminium base with castors suitable for wood floor (Art. 966/F).

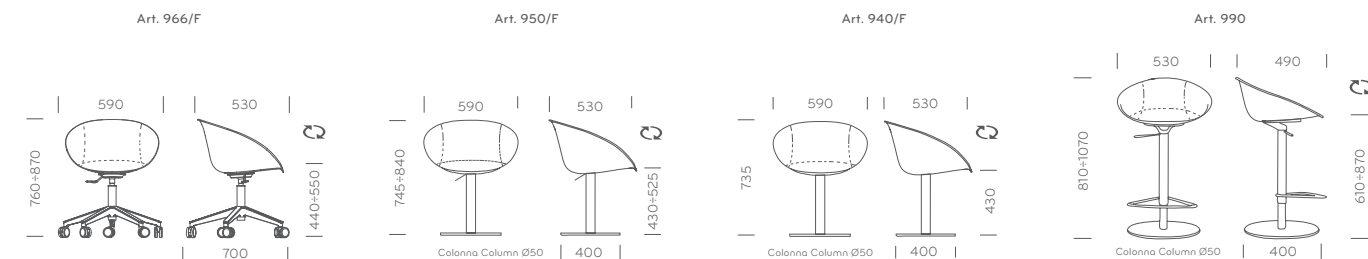

Categoria rivestimenti disponibili: F01, F03, F04, F05, F06, F07, F08, F09
Covering category available: F01, F03, F04, F05, F06, F07, F08, F09



950/F



56 Gliss Soft

Design Claudio Dondoli and Marco Pucci



1050

Art. 1050 - 985

Gliss Soft con scocca in schiumato ignifugo, rivestita in tessuto o finta pelle con cuscino sfoderabile. Base centrale in acciaio inox lucidato girevole con alzato a gas e colonna cromata.

Sgabello su base girevole altezza fissa.

Gliss Soft, injected fire retardant foam shell covered with fabric or simil-leather and removable covering cushion. Stainless steel central swivel base with gas lift device and chromed column. Bar stool version, swivel base fixed height.

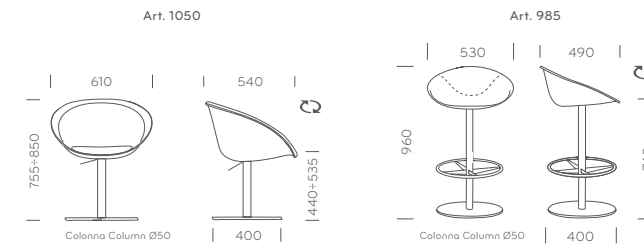

Categorie rivestimenti disponibili:
A, da C01 a C07, da C10 a C22, da C60 a C64, da C90 a C95, G,
da H20 a H35, da H80 a H90

Covering categories available:
A, from C01 to C07, from C10 to C22, from C60 to C64, from C90 to C95, G,
from H20 to H35, from H80 to H90

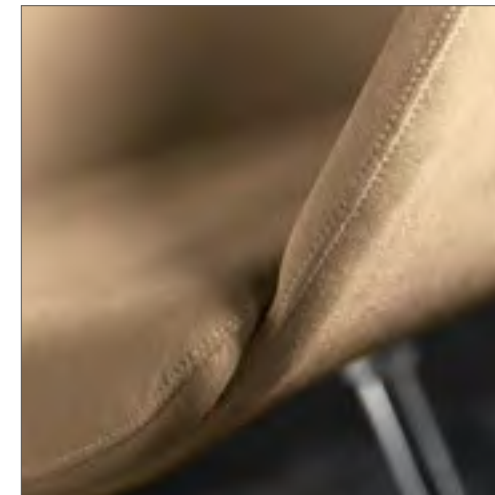

985

PEDRALI DYNAMIC DESIGN

Art. 1020 - 1040 - 912

Gliss Soft in schiumato ignifugo, rivestito in tessuto o finta pelle con cuscino sfoderabile. Disponibile su base centrale girevole in acciaio inox satinato o lucidato altezza fissa (Art. 1040) o su tondino d'acciaio cromato Ø 10 mm (Art.1020).
 Gliss Soft injected fire retardant foam shell covered with fabric or simil-leather. Cushion with removable covering. Brushed or polished stainless steel central swivel base with fixed height (Art.1040) or Ø 10 mm chromed steel rod frame (Art. 1020).

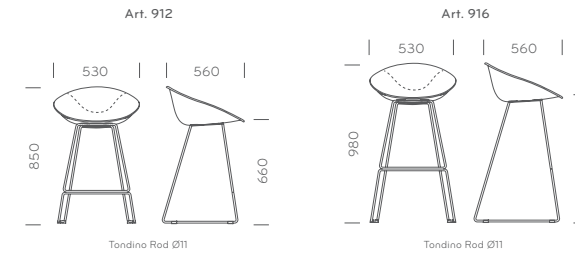
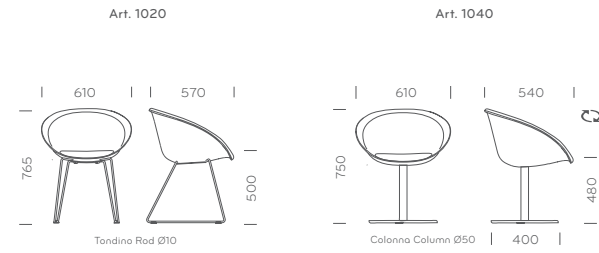

Categorie rivestimenti disponibili:
 A, da C01 a C07, da C10 a C22, da C60 a C64, da C90 a C95, G,
 da H20 a H35, da H80 a H90
 Covering categories available:
 A, from C01 to C07, from C10 to C22, from C60 to C64, from C90 to C95, G,
 from H20 to H35, from H80 to H90



1040



1020



912

60 Grace Soft

Design Marco Pucci and Claudio Dondoli

Art. 413

Grace poltroncina ha i braccioli appena pronunciati. La versione imbottita in schiumato ignifugo, è rivestita in tessuto, vero o finto pelle. Telaio in tondino d'acciaio cromato Ø 11 mm.

Grace armchair, injected foam seat, upholstered with fabric, simil leather or mid grain leather, embracing armrest. Frame in chromed steel rod Ø 11 mm.

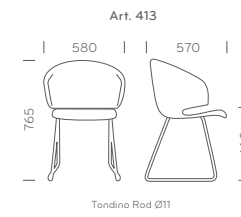

Categorie rivestimenti disponibili: da C01 a C07, da C10 a C22, G, P
Covering categories available: from C01 to C07, from C10 to C22, G, P



62 Leila

Design Maurizio Manzoni and Roberto Tapinassi

Art. 681

Forma monolitica e geometrica per Leila, elegante poltroncina imbottita pensata per il ristorante, l'ufficio e la casa. Caratterizzata da angoli smussati e da un'immagine morbida e confortevole, Leila ha la scocca imbottita rivestita in tessuto, vera o finta pelle e le gambe in essenza di rovere nelle finiture rovere sbiancato, tinto wengé o laccato bianco.

Leila armchair, soft and elegant, with its rigorous and geometrical shape, is conceived for restaurants, offices and homes. Featured by rounded corners and embracing shape, Leila armchair is upholstered in fabric or simil leather or mid grain leather. Oak wood frame in bleached, wengé stained or white lacquered open grains finish.

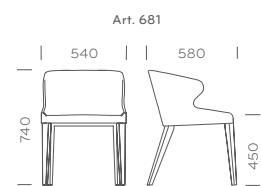

Categorie rivestimenti disponibili: A, C, G, H, P
Covering categories available: A, C, G, H, P

Finiture: / Finishes:



BI
Rovere laccato
bianco poro
aperto
Open grains
white
lacquered oak

RS

W



Art. 682

La poltroncina Leila è proposta anche nella versione con telaio a slitta in tubo d'acciaio Ø 16 mm cromato o satinato.
 Armchair Leila with Ø 16 mm chromed or satinized steel tube frame.

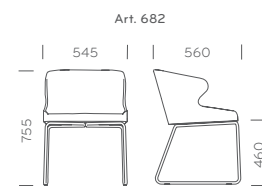

Categorie rivestimenti disponibili: A, C, G, H, P
 Covering categories available: A, C, G, H, P



682

Art. 683 - 687

Leila girevole su base centrale in acciaio inox satinato o lucidato. Disponibile anche la versione sgobello.
 Swivel Leila with brushed or polished stainless steel central base and column. Bar stool version available.

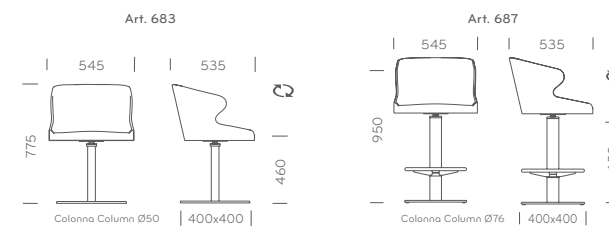

Categorie rivestimenti disponibili: A, C, G, H, P
 Covering categories available: A, C, G, H, P



687



683

66 Blitz Soft

Design Claudio Dondoli and Marco Poggi

Art. 641

Ricercata nei dettagli, Blitz versione interamente rivestita in pelle o ecopelle con cuciture in tinta.
Blitz soft version is entirely covered with mid-grain or simil leather, matching stitches.

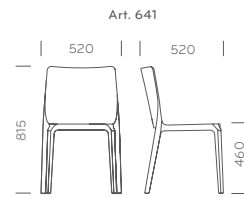

Rivestimento disponibile: categoria A, C, H, P
Covering available: category A, C, H, P



641

Art. 640.3

La seduta foto-incisa della sedia in policarbonato Blitz può ricevere un'imbottitura leggermente incassata rivestita in tessuto o finto pelle.
The seat of polycarbonate chair Blitz has a slight rough finish and can have a recessed padding covered with various fabrics and eco-leather.

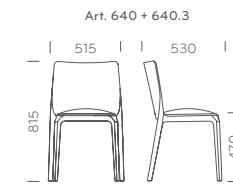

Categorie rivestimenti disponibili: A, C, G, H
Covering categories available: A, C, G, H



641



640+640.3

68 Blitz Soft

Art. 641

La forma rassicurante e la struttura essenziale rendono Blitz facile da inserire in qualsiasi ambiente.
Its cheering shape and its essential structure make Blitz suitable for any environment.



641

69



Art. 641 - Sedie Blitz e basamenti Stylus (Art. 5400) verniciati bianco con ripiano in stratificato Compact Full Colour bianco.
Blitz chairs and Stylus table bases (Art. 5400) in white powder coated finish with Compact Full Colour solid laminate top.

PEDRALI DYNAMIC DESIGN

70 Mood

Design Daniele Lo Scalzo Moscheri

Art. 720

Sedia Mood con anima in acciaio e rivestimento del sedile e schienale in cuoio naturale. Disponibile nei colori nero, marrone scuro, rosso, bianco, grigio e sabbia. Mood chair with steel core and genuine leather covering. Available black, dark brown, red, white, gray and beige.

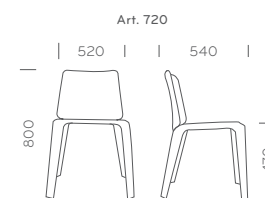

Categorie rivestimenti disponibili: F01, F05, F06, F07, F08, F09
Covering categories available: F01, F05, F06, F07, F08, F09



Sedia Mood e tavolo Aero (Art. TAE_220X106).
Mood chair and Aero table (Art. TAE_220X106).



Tavolo allungabile Magic (Art. TM_200X90) con ripiano in vetro trasparente e struttura in acciaio inox satinato.
 Magic extensible table (Art. TM_200X90), transparent glass top and brushed stainless steel structure.

Sedia Mood imbottita in cuoio naturale con cuciture in tinta. Elegante e prezioso.
 Mood chair with genuine leather upholstery and matching stitches. Stylish and precious.



Design Pedrali R&D

Art. 2481 - 2491

Kuadra XL Soft, forma rigorosa e scocca imbottita a spessore costante. Disponibile nelle versioni sedia e poltrona può avere maniglia sul retro dello schienale, che ne facilita la presa. Telaio in tubolare d'acciaio quadrato 20x20 mm satinato o cromato oppure Ø 16 mm cromato. Tutte le versioni sono impilabili grazie all'applicazione di un pannello sotto la scocca a richiesta.

Kuadra XL Soft, linear shapes and thick upholstered shell. Chair and armchair version available with handle in the back, to move it easier. 20x20 mm square steel tube frame, satinized or chromed, or Ø16 mm chromed. All models can be stackable thanks to a special optional panel applied under the shell.

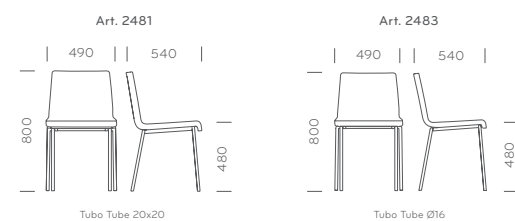

Rivestimento disponibile: categoria A, C, G, H
Covering available: category A, C, G, H

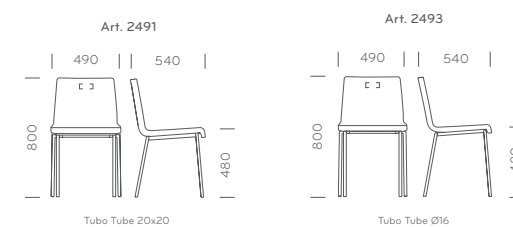

Rivestimento disponibile: categoria A, C, G, da H20 a H35, da H80 a H90
Covering available: category A, C, G, from H20 to H35, from H80 to H90



2481



2491



Art. 2482 - 2492

Poltrona Kuadra XL Soft ha scocca imbottita e può avere maniglia sul retro dello schienale che ne facilita la presa.
 Telaio in tubolare d'acciaio quadrato 20x20 mm satinato o cromato oppure Ø 16 mm cromato.
 Kuadra XL Soft armchair with upholstered shell and handle in the back to move it easier. Satinized or chromed 20x20 mm square steel tube frame or Ø 16 mm chromed.

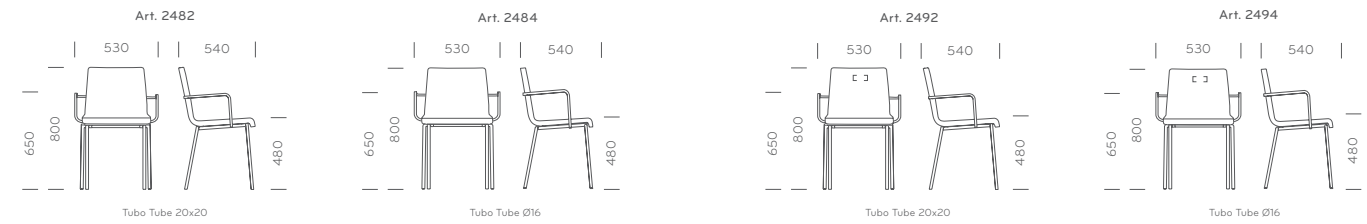

Rivestimento disponibile: categoria A, C, G, H
 Covering available: category A, C, G, H

Rivestimento disponibile: categoria A, C, G, da H20 a H35, da H80 a H90
 Covering available: category A, C, G, from H20 to H35, from H80 to H90



2492



2482



Art. 4429

Lo sgabello Kuadra XL Soft completa la famiglia XL Soft; la scocca ha spessore costante, disponibile con rivestimento in tessuto o finta pelle. Seduta girevole con meccanismo di ritorno automatico. Ha base centrale e colonna in acciaio inox satinato da 50x50 mm.

Kuadra XL soft stool completes XL Soft family. The shell with constant thickness covered with fabric or simil leather. Swivel seat with spring back device, brushed stainless steel central base and column, 50x50 mm.

Art. 4429

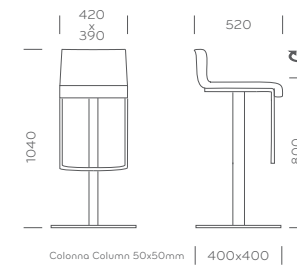

Rivestimento disponibile: categoria A, C, G, H
Covering available: category A, C, G, H





2463/F18

Art. 2463 - 2464

Sedia e poltrona Kuadra XL con rivestimento in cuoio naturale o rigenerato. Telaio in tubo d'acciaio Ø 16 mm cromato o 20x20 mm cromato o satinato che diviene anche bracciolo.
 Kuadra XL chair and armchair, shell covered with genuine or regenerated leather. Chromed Ø 16 mm chromed or 20x20 mm chromed or satinized steel tube frame becomes also armrests.

Kuadra XL Cuoio 81

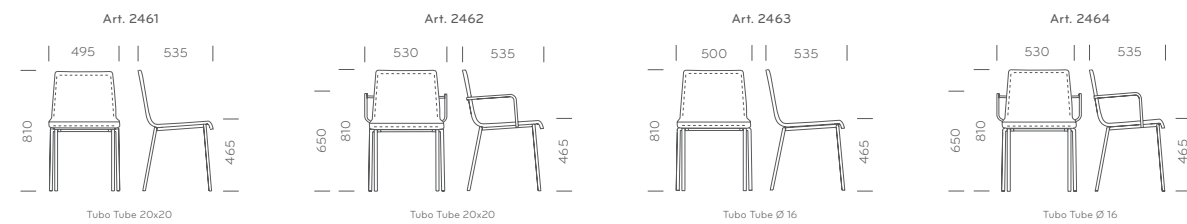

Rivestimento disponibile: categoria F
 Covering available: category F



2464/F13



2464/F18



Art. 1058 - 1051

Sedia Kuadra Soft con scocca rivestita in tessuto o finto pelle. Telaio in tondino d'acciaio Ø10 mm o gambe in tubo d'acciaio Ø16 mm e 20x20 mm. Tutte le versioni possono essere impilabili grazie all'applicazione di un pannello sotto la scocca a richiesta.

Kuadra Soft chair, shell covered with fabric or simil leather. Ø10 mm steel rod frame or Ø16 mm and 20x20 mm steel tube legs. All models can be stackable, thanks to a special optional panel, applied under the shell.

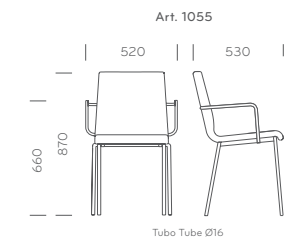
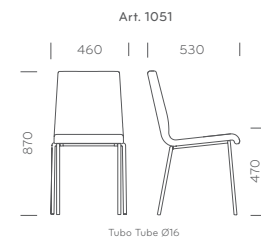
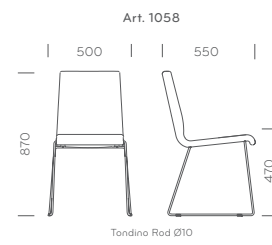

Categorie rivestimenti disponibili: A, C, G, da H20 a H35, da H40 a H53
 Covering categories available: A, C, G, from H20 to H35, from H40 to H53



1058



1051

86 Kuadra Cuoio

Art. 1298

Kuadra con rivestimento in cuoio naturale o rigenerato, cuciture a vista. Telaio in fondino d'acciaio cromato Ø 10 mm. Può essere impilabile grazie all'applicazione di un pannello sotto la scocca a richiesta.
Kuadra covered with genuine or regenerated leather, visible stitches. Ø 10 mm chromed steel rod frame. It can be stackable, thanks to a special optional panel, applied under the shell.

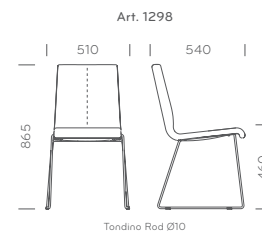

Rivestimento disponibile: categoria F
Covering available: category F



1298/F12



Art. 1291 - 1281 - 4427/F - 4429/F

Kuadra con rivestimento in cuoio naturale o in rigenerato di cuoio, cuciture a visto. Struttura disponibile in tubo d'acciaio a sezione quadrata 20x20 mm cromato o satinato o con sezione tonda da Ø16 mm nella finitura cromato o cromato opaco. Kuadra sgabello versione girevole con base in acciaio inox satinato. Kuadra chair, covered with genuine or regenerated leather with visible stitches. Chromed or satinized 20x20 mm steel tube frame or Ø 16 mm steel tube frame available chromed or mat chromed. Kuadra stool version with brushed stainless steel swivel central base.

Art. 1291

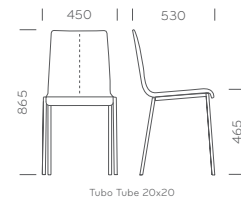

Art. 1281

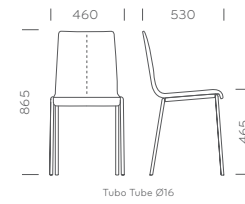

Art. 4427/F

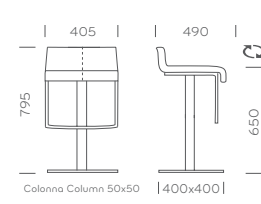

Art. 4429/F

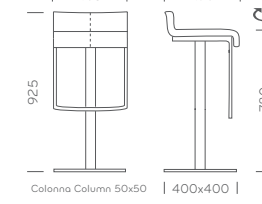

Categoria rivestimenti disponibile: F
Covering category available: F



1291/F03



1281/F19



4427/F03



4429/F01

90 Trend Cuoio

Design Pedrali R&D

Art. 448

Sedia Trend con scocca rivestita in cuoio rigenerato, cuciture in tinta. Struttura in tondino d'acciaio cromato Ø 10 mm o in tubo d'acciaio Ø 16 mm, cromato o cromato opaco.

Trend chair with regenerated leather covered shell, matching stitches. Ø 10 mm chromed steel rod frame or Ø 16 mm chromed or matt chromed steel tube frame.

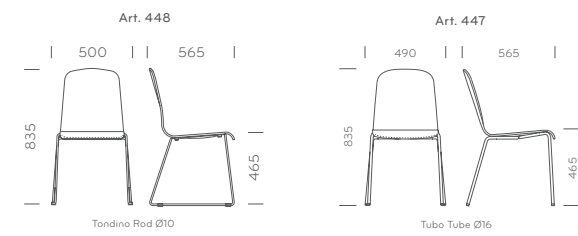

Categorie rivestimenti disponibili: F11, F12, F17, F18, F19
Covering categories available: F11, F12, F17, F18, F19



92 Mya Soft

Design Claudio Dondoli and Marco Poggi

Art. 710

Sedia Mya con gambe in pressofusione di alluminio lucidato o spazzolato e imbottitura del sedile e dello schienale in vera o finta pelle. Mya sedia è impilabile grazie al fondo imbottito sotto la seduta. Mya è disponibile anche in versione poltrona. Mya chair with die-casted aluminium legs, polished or brushed finishes. Seat and back upholstered in mid-grain or simil leather. Mya chair Soft version is stackable thanks to the upholstery at the bottom of the seat. Mya armchair version also available.

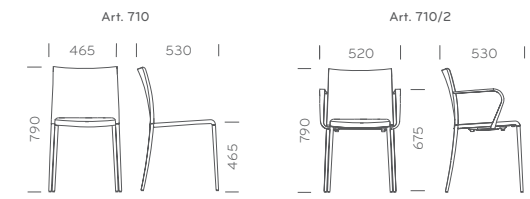

Categorie rivestimenti disponibili: A, P, da H20 a H35, da H80 a H90
Covering categories available: A, P, from H20 to H35, from H80 to H90



Art. 711

Sedia Mya con gambe in pressofusione di alluminio lucidato e spazzolato e imbottitura del sedile e dello schienale in finta pelle. Struttura dello schienale in polipropilene nero. Disponibile con gambe verniciate. Mya sedia è impilabile grazie al fondo imbottito sotto il sedile.

Mya chair, die casted aluminium frame polished or brushed, seat and back upholstered in simil leather. Black polypropylene back. Available with powder coated legs. Mya chair is stackable thanks to the foam panel under the seat.



Mya soft, dettaglio dell'imbottitura sotto il sedile che garantisce l'impilabilità della sedia senza recare danni al rivestimento.

Mya Soft, detail of the upholstery under the seat which ensures the stackability of chair without damaging the fabric/leather covering.

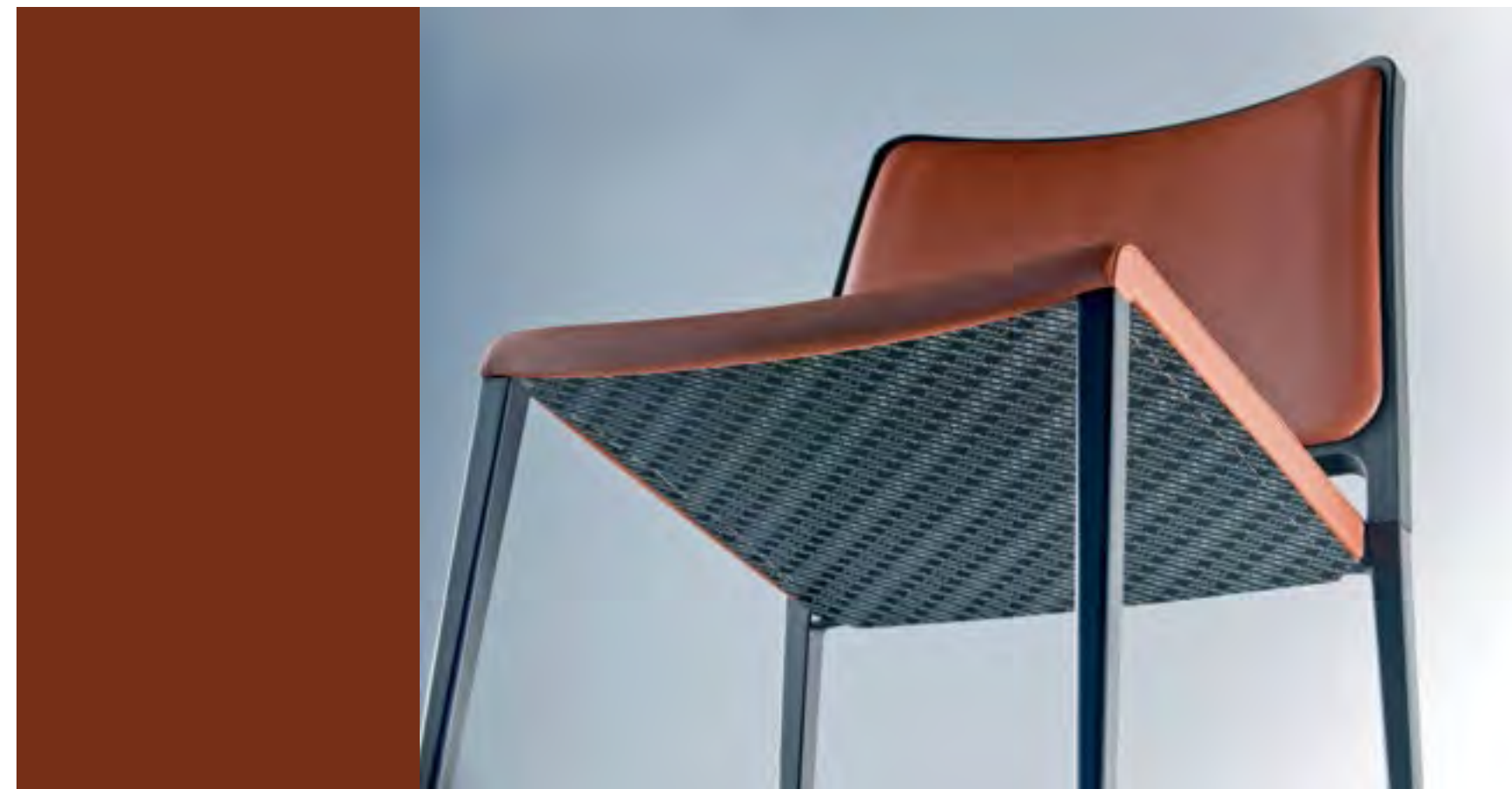

96 Modus Lineare

Design Pedrali R&D

Art. MDL

Modus è una collezione di sedute imbottite modulari disponibili in due larghezze standard (100 cm e 130 cm) o a misura compreso tra i 75 e i 129 cm. Tre le altezze possibili: 110 cm, 175 cm, 240 cm; rivestimento in tessuto o pelle. I moduli lineari, liberamente componibili, possono soddisfare ogni configurazione d'arredo. Modus is a modular soft sitting system available in two standard widths (100 cm and 130 cm) or in customized width from 75 to 129 cm. Three standard heights: 110 cm, 175 cm, 240 cm horizontal stitches; fabric covering. Modular linear units can satisfy every furnishing requirements.

97



Modus Lineare con cuciture orizzontali altezza 240 cm; rivestimento in tessuto.
Modus Linear with backrest heigh 240 cm, horizontal stitches; fabric covering.

MDL_110_L100

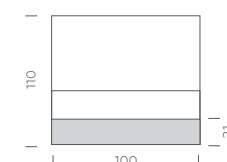

MDL_110_L130

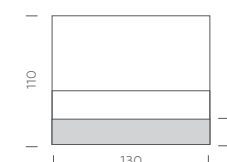

Autoportante / Free-standing.

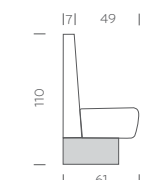

MDL_175_L100

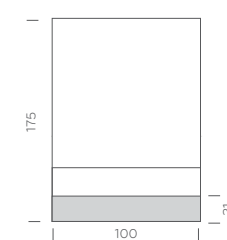

MDL_175_L130

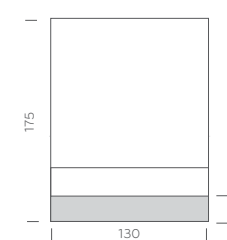

Autoportante / Free-standing.

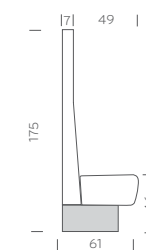

MDL_240_L100

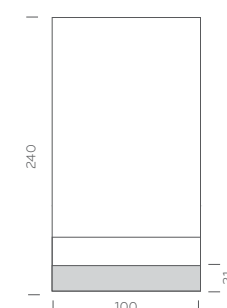

MDL_240_L130

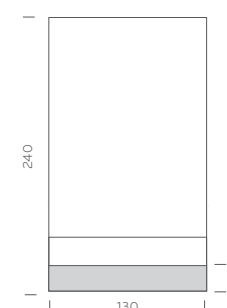

Fissato a parete / To be fixed to the wall.

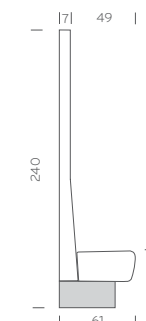

Le misure dei moduli Modus sono espresse in cm. / Dimensions of Modus units are expressed in centimeters.

Art. MDL

Lo schienale delle panche Modus, in poliuretano espanso non deformabile, può essere liscio, con bottoni, con cuciture orizzontali o con lavorazione capitoné. Sedile e schienale, rivestiti in finta pelle, tessuto o tessuto cliente, possono avere rivestimenti diversi.
 Backrest is made by non-deformable polyurethane foam, smooth upholstered, with decorative stitches, buttons or capitoné manufacturing. Seat and back, covered in simil-leather, fabric or customer own material, can have different fabric covering.

Modus è omologato e certificato dal Ministero degli Interni nella classe di reazione al fuoco 1 IM (UNO I EMME).
 Modus obtained fire reaction classification Classe 1 IM (UNO I EMME) from Ministero degli Interni.

Tipologie di schienale
 Backrest upholstered examples

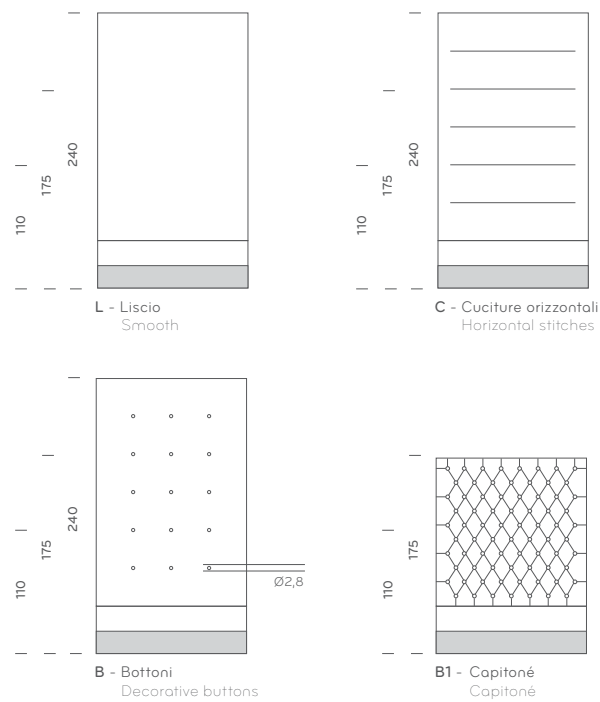

Le misure dei moduli Modus sono espresse in cm.
 Dimensions of Modus units are expressed in centimeters.

Modus lineare altezza 240 cm con rivestimento in finta pelle; sedili con bottoni e cuciture orizzontali.
 Modus linear bench with backrest height 240 cm with simil leather covering; backrests with decorative buttons or horizontal stitches.

Art. MD4

Zoccolo frontale a misura in estruso di alluminio satinato o anodizzato nero. Disponibile a richiesta lo zoccolo laterale con angolare in fusione di alluminio. Montati ad incastro, gli zoccoli sono coordinati da una bordura antipolvere in materiale plastico ideale a compensazione di pavimenti irregolari o per nascondere inestetismi.
 Front kickboard in extruded aluminium or anodized black. On request also available side kickboard with die-casted aluminium corner. Both kickboards are fit together and provided with plastic dust-resistant edge, to compensate irregular floors or to cover imperfections.

Art. MD4

Zoccolo disponibile nei colori:
 Baseboard finishes available:



100 Modus Lineare
Capitoné

Art. MDL

Elegante e ricercata la versione Modus con schienale in pelle lavorazione Capitoné, disponibile in due altezze, abbinato a sedile con imbottitura liscia senza cuciture.
The Modus version with back in Capitoné leather is elegant and refined. It's available in two different heights in combination with a seat with no stitches smooth upholstery.

101





Art. MDP

Modus può essere inserito all'interno di nicchie oppure posizionato a parete. I moduli lineari standard da 130 cm o 100 cm possono infatti essere affiancati a moduli dalla larghezza personalizzata compresa tra i 75 e i 129 cm, ideali per soddisfare qualsiasi esigenza d'arredo. I moduli personalizzati, disponibili nelle 3 altezze 110 cm, 175 cm e 240 cm possono avere rivestimento liscio o con cuciture orizzontali.

Modus can be placed inside niches or against a wall. The standard linear versions measure 130 cm or 100 cm can be joined with modules having customized widths from 75 cm to 129 cm, suitable for any furnishing need. The customized Modus, available in 3 different heights 110 cm, 175 cm and 240 cm, can have a smooth upholstered backrest or horizontal stitches.

Modus Lineare Personalizzato 103

Su misura

MDP_110

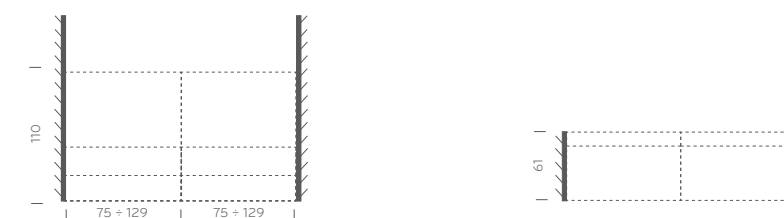

Autoportante.

Quando Modus ha un fianco appoggiato a parete, indicare nell'ordine la dimensione della panca desiderata sottraendo 1 cm.

Free-standing.

If the side of the bench has to be placed next to the wall, we advise to order the bench 1 cm. shorter than the wall space available.

MDP_175

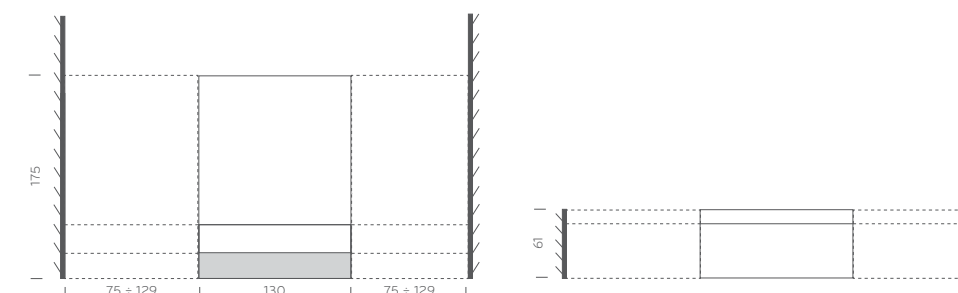

Autoportante.

Quando Modus ha un fianco appoggiato a parete, indicare nell'ordine la dimensione della panca desiderata sottraendo 1 cm.

Free-standing.

If the side of the bench has to be placed next to the wall, we advise to order the bench 1 cm. shorter than the wall space available.

MDP_240

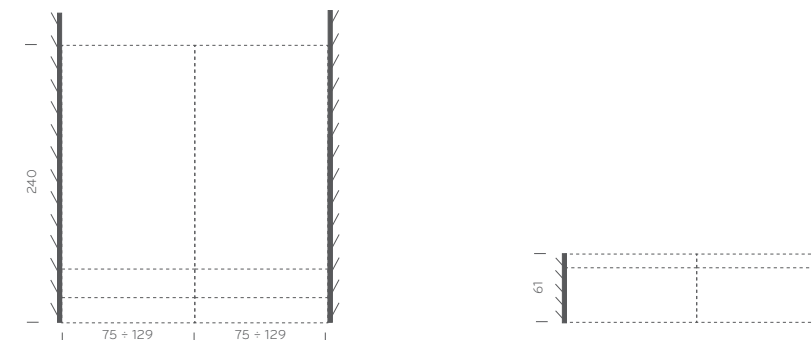

Fissato a parete.

Quando Modus ha un fianco appoggiato a parete, indicare nell'ordine la dimensione della panca desiderata sottraendo 1 cm.

To be fixed to the wall.

If the side of the bench has to be placed next to the wall, we advise to order the bench 1 cm. shorter than the wall space available.

Tipologie di schienale

Backrest upholstered examples

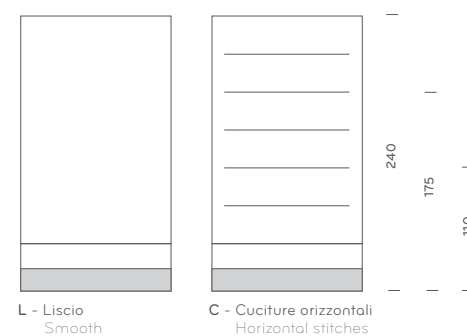
L - Liscio
SmoothC - Cuciture orizzontali
Horizontal stitches

Le misure dei moduli Modus sono espresse in cm. / Dimensions of Modus units are expressed in centimeters.

Art. MDA

Modus Angolare completa le configurazioni più complesse con angoli di 90°. Disponibile con diversi disegni delle imbottiture e nelle diverse altezze 110 cm, 175 cm e 240 cm. Può essere accessorata con pannello di rivestimento posteriore su uno dei due lati.
 Modus, Corner unit at 90 degrees, allows to create multiple configurations of seats. Upholstered Backrest can be in different heights 110 cm, 175 cm, 240 cm. Backside panel available for one of the two sides.



Modus Angolare altezza 110 cm con rivestimento in finta pelle diverso per sedile e schienale.
 Modus Corner unit with backrest height 110 cm, different covering for backrest and seat in simil leather.

MDA_110

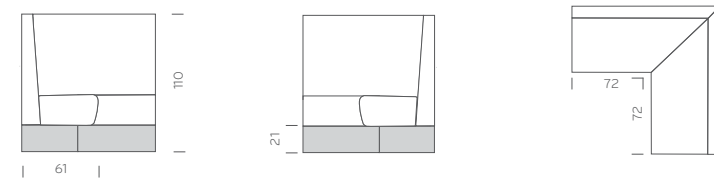

Autoportante, può essere fissato anche al pavimento.
 Free-standing, it can be fixed to the floor.

MDA_175

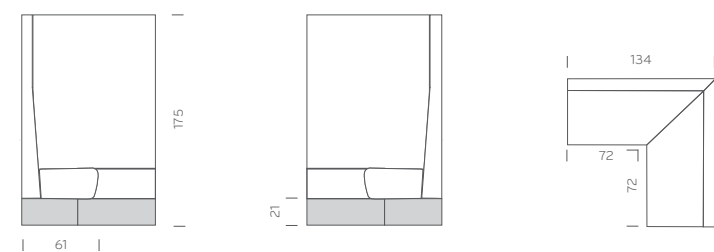

Autoportante, può essere fissato anche al pavimento.
 Free-standing, it can be fixed to the floor.

MDA_240

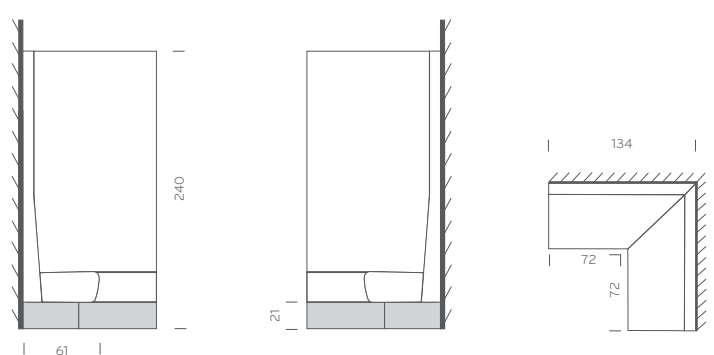

Fissato a parete, può essere anche fissato a pavimento.
 To be fixed to the wall. It can be fixed to the floor.

Tipologie di schienale
 Backrest upholstered examples

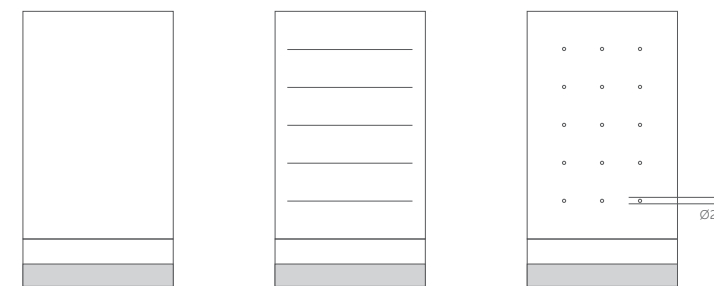

L - Liscio Smooth
 C - Cuciture orizzontali Horizontal stitches
 B - Bottoni Decorative buttons

Le misure dei moduli Modus sono espresse in cm.
 Dimensions of Modus units are expressed in centimeters.



Modus Angolare h 175 cm schienale con cuciture orizzontali.
 Modus, Corner bench, backrest 175 cm upholstered with horizontal stitches.



Modus Bifacciale altezza 110 cm, versione con imbottitura liscia.
Modus Face to Face version with backrest height 110 cm, smooth finish for the upholstery.

Art. MDB

La versatilità delle panche modulari Modus permette di avere una versione bifacciale dove gli schienali dei singoli moduli sono appoggiati l'uno all'altro. Questa versione può essere usata al centro della stanza o appoggiata lateralmente a parete. Lo schienale può essere liscio, con cuciture orizzontali, bottoni o lavorazione capitoné. Due le altezze disponibili. Modus, back to back unit, is a functional bench that help to optimize the spaces. It can be placed in the center of the room or aside a wall. Backrest simply upholstered or with decorative stitches, buttons or capitoné manufacturing. Two heights available.

MDB_110_L100

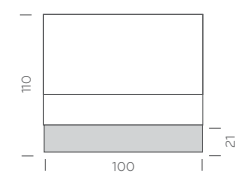

MDB_110_L130

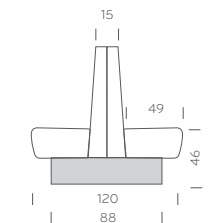
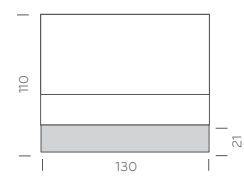

Autoportante / Free-standing.

MDB_175_L100

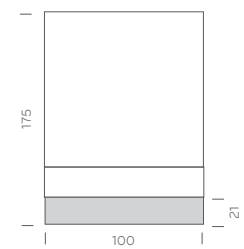

MDB_175_L130

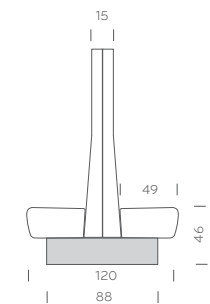
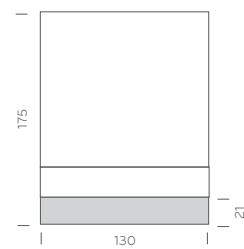

Autoportante / Free-standing.

Tipologie di schienale
Backrest upholstered examples

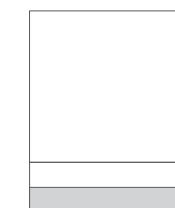

L - Liscio
Smooth

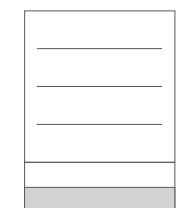

C - Cuciture orizzontali
Horizontal stitches

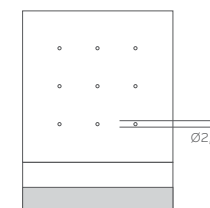

B - Bottoni
Decorative buttons

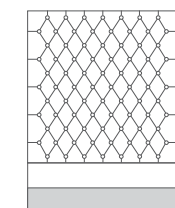

B1 - Capitoné
Capitoné



Le misure dei moduli Modus sono espresse in cm.
Dimensions of Modus units are expressed in centimeters.

La panca Modus viene arricchita da un pannello di rivestimento posteriore in laminato, disponibile in diverse finiture. Questo permette di usare la panca come elemento separatore, come quinta per dividere o creare nuovi spazi. Disponibile sia per Modus Lineare che per Modus Angolare. La configurazione Modus Angolare può essere accessoriata con pannello di rivestimento posteriore solo su uno dei due lati. Il lato non rivestito dal pannello deve essere appoggiato a parete.
 The backside of the benches can be covered by a laminate panel, available in different finishes. This configuration allows to separate different areas and create new spaces and atmospheres. Available for Modus Linear and Modus Corner Unit. For Modus Corner Unit configuration the backside panel is available for one of the two sides only. The free side not covered with panel must be placed aside the wall.

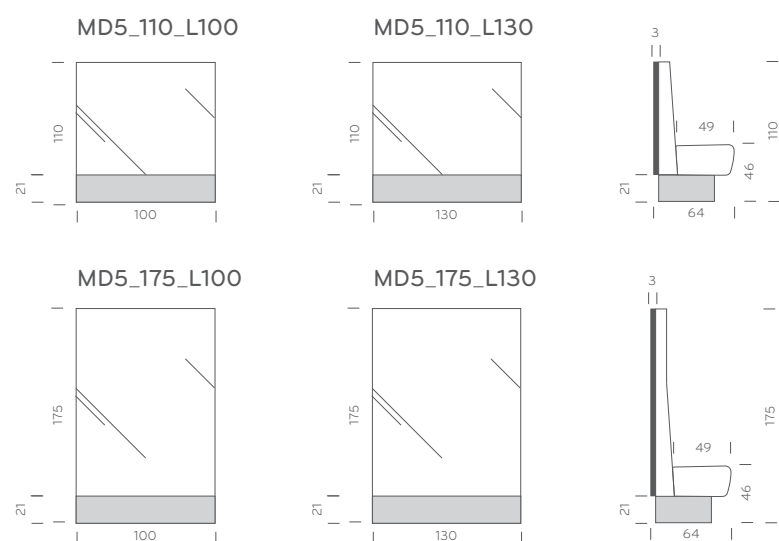

Le misure dei moduli Modus sono espresse in cm.
 Dimensions of Modus units are expressed in centimeters.

Art. MD5
 Pannello in laminato con bordo in ABS, spessore 30 mm, disponibile nei colori:
 Laminate backside panel with ABS edge, thickness 30 mm, colours available:

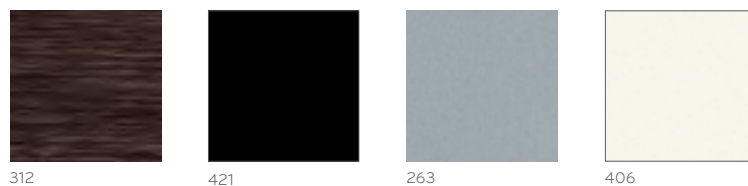

Art. 202 - 200 - 201 - 203

Nuovo sistema modulare di sedute Host. Lineare e rigoroso nella forma può essere posizionato in spazi più o meno compatti per creare aree di attesa o di relax a seconda delle esigenze. L'altezza della seduta e la sua profondità lo rendono confortevole anche per un lunch o un aperitivo.

Host new modular seating system. Thanks to its linear and rigorous shape, it can be placed in compact spaces to create waiting rooms or relaxation areas in order to meet different needs. The height of the seating and its depth make it suitable both for a lunch and for a happy-hour.



Art. 202 - 200 - 201 - 203

Il sistema comprende 4 diverse unità che si prestano a numerose combinazioni e personalizzazioni: divano, seduta singola, seduta angolare con schienale e pouf. Il telaio è in tubo d'acciaio cromato di Ø 16 mm, la seduta è completamente imbottita con uno schiumato poliuretano ignifugo che la rende morbida ed indeformabile. Rivestimento in tessuto o finta pelle.

The system includes 4 different units suitable to different combinations and personalization: sofa, single seating, angular seating with backrest and pouf. The frame is made of a rod steel tube with Ø 16 mm, the shell is completely upholstered with a fire-retardant injected polyurethane foam that makes it soft and unshrinkable. Fabric or simil leather upholstery covering.

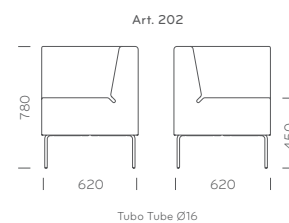

Categorie rivestimenti disponibili: A, C, G, H
Covering categories available: A, C, G, H

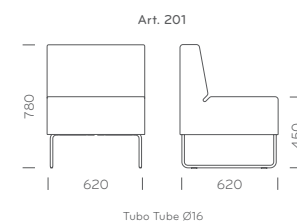
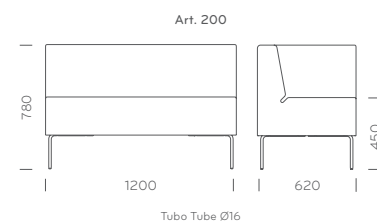

Categorie rivestimenti disponibili: A, C, G, H
Covering categories available: A, C, G, H

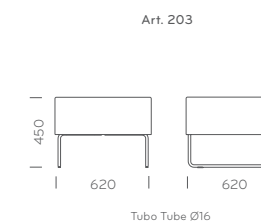

202



200



201



203



Moduli Host o configurazione angolare.
Angular configuration with Host modular units.

Art. 220 - 221 - 222 - 223

Host versione sgabello ha telaio in tubo d'acciaio 25x25 mm cromato o verniciato nero. Scocca imbottita rivestita in tessuto o finta pelle. 4 i moduli disponibili: divano, seduta singola, angolare, pouf.
 Host stool version, 25x25 mm steel tube frame in chromed or black powder coated finish. Upholstered shell covered with fabric or simil leather. 4 different units available: sofa unit, single seat unit, corner unit, sofa unit.

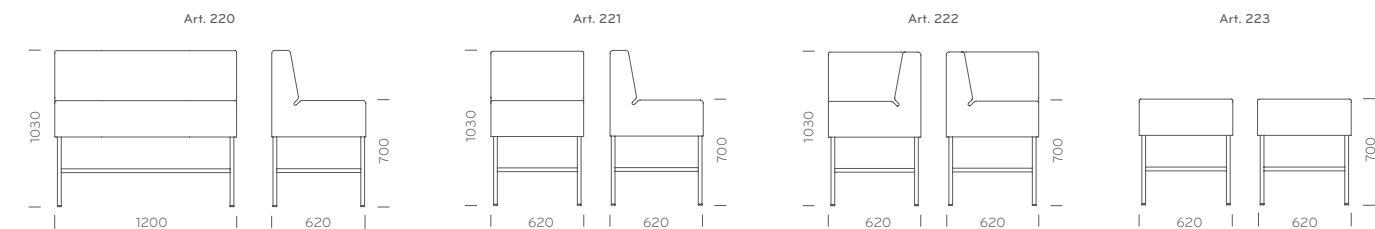

Categorie rivestimenti disponibili: A, C, G, H
 Covering categories available: A, C, G, H



Divano a moduli Host.
 Sofa of Host modular units.



221



222

118 Host Lounge

Design Marco Pocci and Claudio Dondoli

Art. 791 - 793

Host Lounge, sistema di sedute modulari composto da due elementi diversamente accostabili: seduto singola e seduto singola con schienale. Gli elementi sono imbottiti in schiumato poliuretano ignifugo. Telaio in tubo d'acciaio Ø 16 mm cromato.
Host Lounge informal modular sitting system, composed by two elements variously joinable: single seat unit and single seat backrest unit. Upholstered with fire retardant polyurethaneic injected foam, fabric covered. Ø 16 mm chromed steel tube frame.

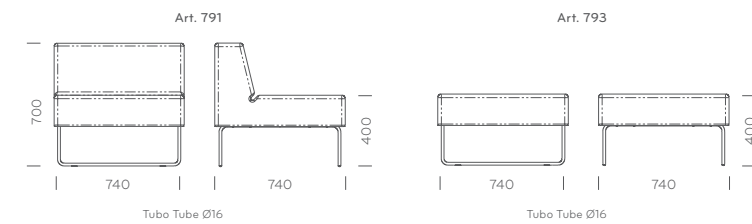

Categorie rivestimenti disponibili: A, H
Covering categories available: A, H



120 Host Lounge



791

Art. 790/G

I moduli Host Lounge possono essere uniti tra loro da un gancio di collegamento in nylon.
Host Lounge modular unit can be joined together by a nylon linking device.

Art. 790/G

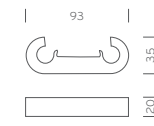

793

Art. 320 - 321 - 322 - 323 - 324 - 325

I pouf Wow, dalle forme tonde, quadrate o rettangolari, donano un tocco ironico e casual agli ambienti collettivi e domestici. Imbottiti in schiumato poliuretano ignifugo, sono disponibili in un'ampia scelta di tessuti e colori.

Pouf Wow with round, square or rectangular shape give a touch of irony and casualness to public and domestic areas. The upholstery is made of fire-retardant injected polyurethane foam that can be covered with a wide selection of fabrics and colours.



Art. 320

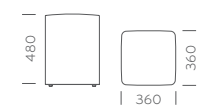

Art. 321

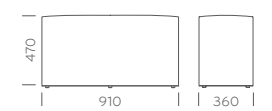

Art. 324

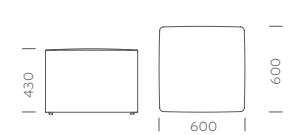

Categorie rivestimenti disponibili: A, C, G, H
Covering categories available: A, C, G, H

Art. 322

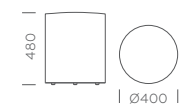

Art. 323

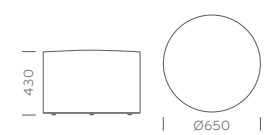

Art. 325

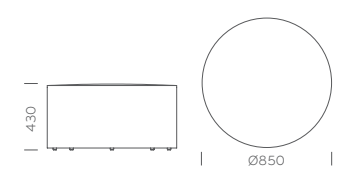

Categorie rivestimenti disponibili: A, C, G, H
Covering categories available: A, C, G, H



Art. 415

Poltrona Mies rivestita in vero o finta pelle.
Telaio in acciaio inox satinato 30x6 mm.
Mies armchair covered with mid grain or
simil leather. Brushed stainless steel frame
30x6 mm.

Art. 415

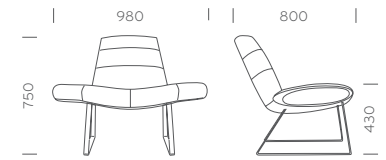

Categorie rivestimenti disponibili: P, H
Covering categories available: P, H

126 Mies

Art. 415

Mies è la seduta lounge ideale per le sale d'attesa degli ambienti più esclusivi.
Mies lounge chair, an appropriate contemporary solution for exclusive waiting areas.

127



128 Joker

Design Roberto Semprini

Art. 417

Joker è la seduta che non ti aspetti. È una poltroncina lounge che abbraccia grazie alla morbida ed avvolgente scocca imbottita tenendo comodamente sospesi nel vuoto. Telaio in acciaio inox satinato.

Joker is a seat with an unexpected look, a comfortable lounge armchair that can softly embrace thanks to its upholstered shell suspended in the air. Brushed s/steel frame.

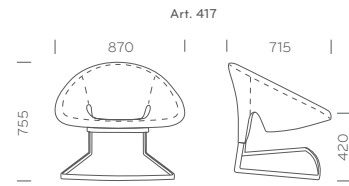

Categorie rivestimenti disponibili: H, P
Covering categories available: H, P



417



129



132 Island

Design Marco Pocci and Claudio Dondoli

Art. 795 - 796 - 797

Semplici nel concetto ma formidabili nell'utilizzo le sedute non convenzionali Island, ideali o complemento di zone relax e d'attesa o per la zona conversazione. Disponibile la versione poltrona e i pouf in due diverse dimensioni. Provvisti di fondo antiscivolo.

Island unconventional sittings, an easy concept, suitable for relax areas, waiting lounge or living rooms. Armchair and low stool version available, in 2 sizes. Anti-slipping bottom surface.

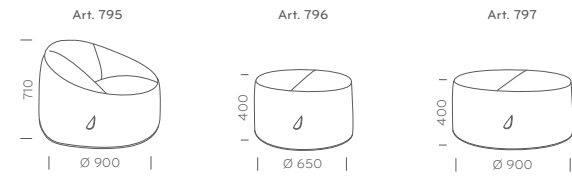

Categorie rivestimenti disponibili: B01, B02, da C90 a C93
Covering categories available: B01, B02, from C90 to C93



Provvisto di maniglia.
Supplied with handle.





Art. 795 - 797

Island pouf e poltrona rivestiti in finta pelle.
Island pouf and armchair with simil leather covering

Finta pelle - Simil leather - Similicuir - Kunstleder - Imitacion de piel



A70

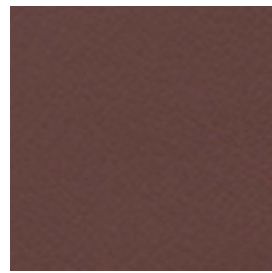

A71



A72



A73



A80



A82



A89



A90

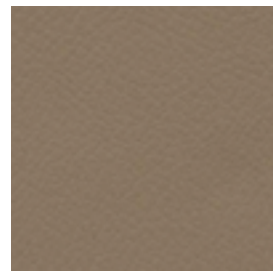

A91



A92

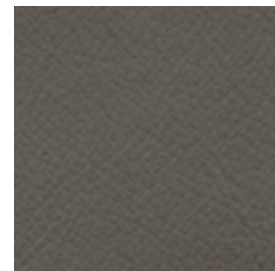

A93

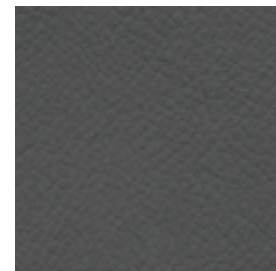

A94

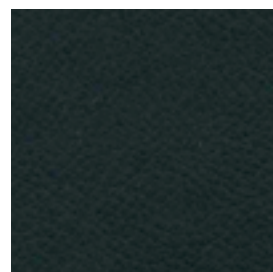

A95



A96



Tessuto ignifugo - Fire retardant fabric - Tissu non-feu - Feuerhemmende Stoffe - Tela ignifuga



A10



A11



A14

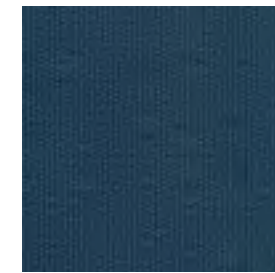

A13

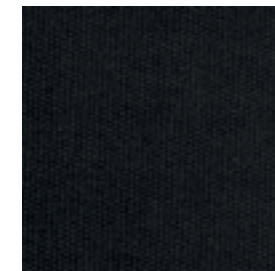

A12

Categoria B

Nylon - Nylon - Nylon - Nylon - Nylon

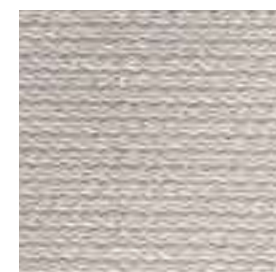

B01

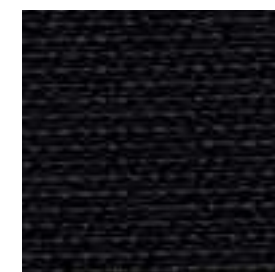

B02

Disponibile solo per art. 795, 796, 797 / Available for art. 795, 796, 797 only

138 Categoria C



Finta pelle ignifuga - Fire retardant simil leather - Similicuir non-feu - Feuerhemmender Kunststoff - Imitacion de piel ignifuga



C18

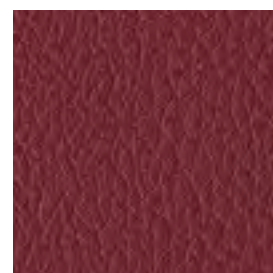

C11



C12



C13

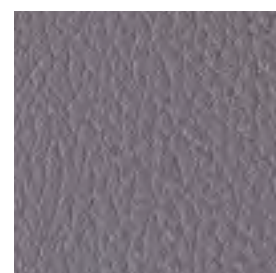

C15



C10



C17



C14



C20

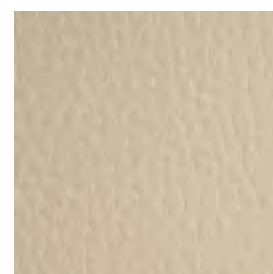

C21

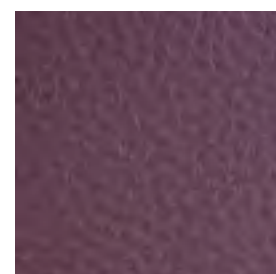

C22

Categoria C 139



Finta pelle ignifuga - Fire retardant simil leather - Similicuir non-feu - Feuerhemmender Kunststoff - Imitacion de piel ignifuga



C90



C91



C92



C93

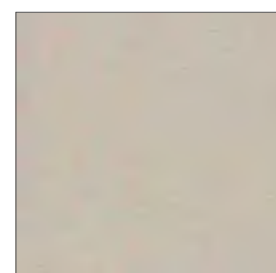

C94

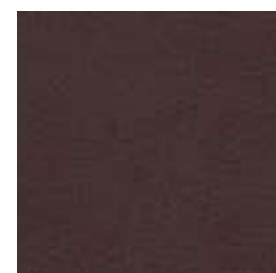

C95



C60



C61



C62



C63



C64

Pedrali può offrire prodotti rivestiti con tessuto categoria C conformi alla Classificazione di reazione al Fuoco omologati CLASSE 1 IM ottenuta dal Ministero dell'Interno. La certificazione viene fornita se richiesta al momento dell'ordine.

Pedrali can offer products upholstered in fabric category C in compliance with fire reaction classification CLASSE 1 IM obtained by Ministry of the Interior. Certificate available if requested together with the order.

140 Categoria C



Tessuto ignifugo - Fire retardant fabric - Tissu non-feu - Feuerhemmende Stoffe - Tela ignifuga



C50



C54



C56



C55



C51



C52



C53



C57

Categoria C



Lana ignifuga - Fire retardant wool - Laine non-feu - Feuerhemmende Wolle - Lana ignifuga

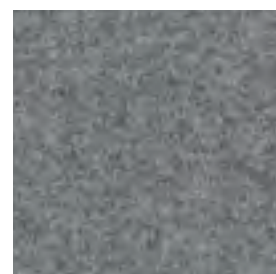

C01



C02

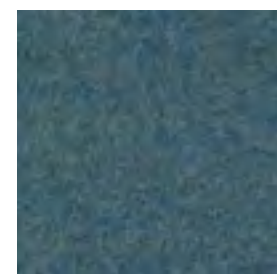

C03



C04

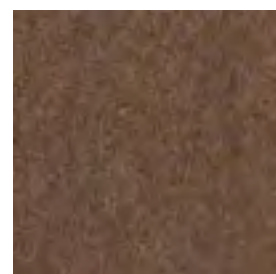

C05



C06

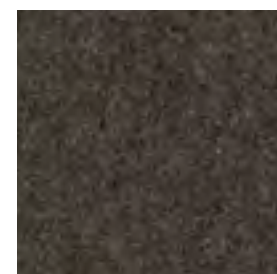

C07

Pedrali può offrire prodotti rivestiti con tessuto categoria C conformi alla Classificazione di reazione al Fuoco omologati CLASSE 1 IM ottenuta dal Ministero dell'Interno. La certificazione viene fornita se richiesta al momento dell'ordine.

Pedrali can offer products upholstered in fabric category C in compliance with fire reaction classification CLASSE 1 IM obtained by Ministry of the Interior. Certificate available if requested together with the order.

Categoria C 141



Tessuto ignifugo - Fire retardant fabric - Tissu non-feu - Feuerhemmende Stoffe - Tela ignifuga



C74



C75



C76



C77



C78

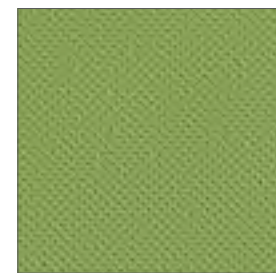

C79

Categoria C



Finta pelle ignifuga - Fire retardant simil leather - Similcuir non-feu - Feuerhemmender Kunststoff - Imitacion de piel ignifuga

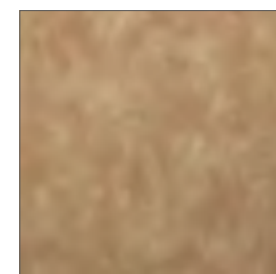

C45

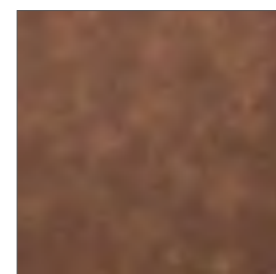

C46

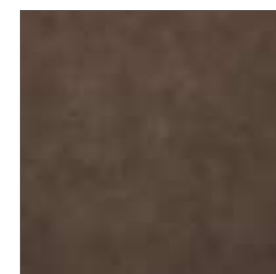

C47

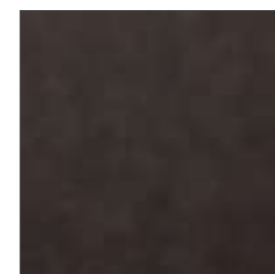

C48

142 Categoria F

Cuoio naturale - Genuine leather - Cuir naturel - Natural Leder - Cuero natural



F05



F01



F04



F03



F06



F07



F08



F09



Tessuto ignifugo - Fire retardant fabric - Tissu non-feu - Feuerhemmende Stoffe - Tela ignifuga



G07



G06



G01



G04



G08



G09

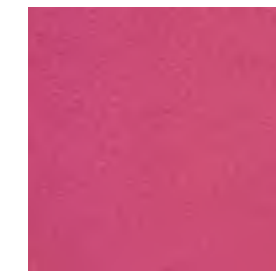

G10

Categoria G 143

Categoria F

Cuoio rigenerato - Regenerated leather - Cuir reconstitué - Lederfaserstoff - Regenerado de cuero



F11



F12



F13



F17



F18



F19



Lana ignifuga - Fire retardant wool - Laine non-feu - Feuerhemmende Wolle - Lana ignifuga

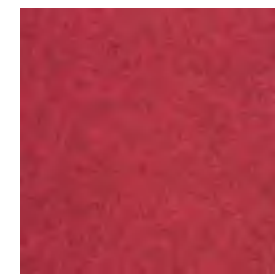

G21



G22



G23



G24



G25

Categoria G

144 Categoria G



Tessuto ignifugo - Fire retardant fabric - Tissu non-feu - Feuerhemmende Stoffe - Tela ignifuga



G59



G60



G61

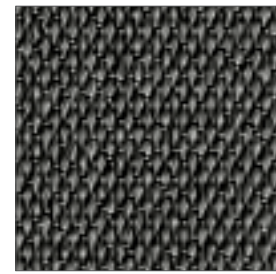

G62

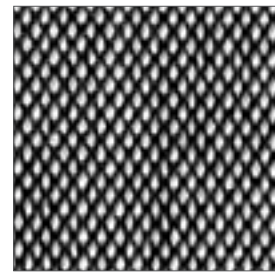

G63

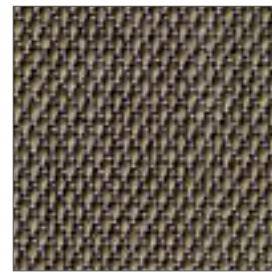

G64

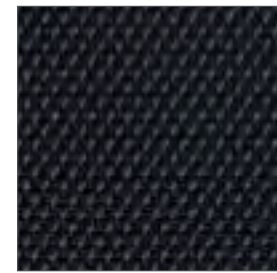

G65



G66



G67



G68



G69

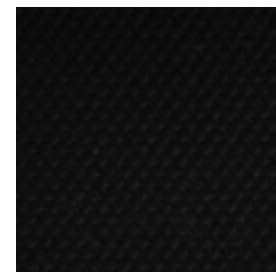

G70

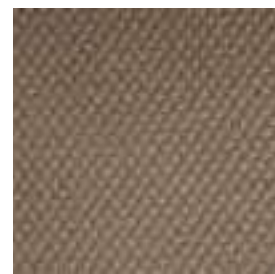

G71

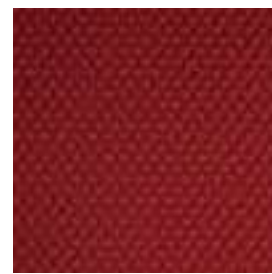

G72

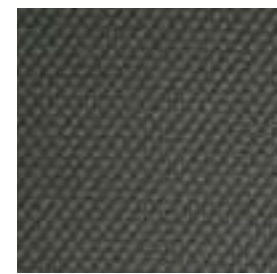

G73



G74

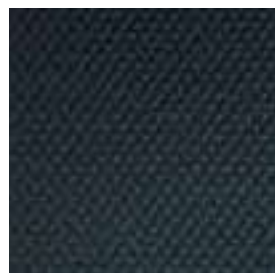

G75

Categoria G/C 145



Tessuto ignifugo - Fire retardant fabric - Tissu non-feu - Feuerhemmende Stoffe - Tela ignifuga



G90*



C72



C70



G91*

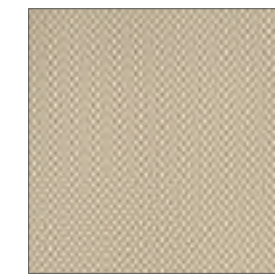

C71

* Disponibile solo per art. 640.3 / Available for art. 640.3 only

146 Categoria H



Finta pelle ignifuga - Fire retardant simil leather - Similcuir non-feu - Feuerhemmender Kunststoff - Imitacion de piel ignifuga



H30



H29



H28



H27



H24



H22



H23



H21



H20

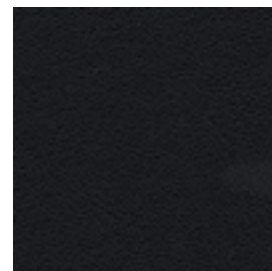

H26



H31



H32



H33



H34

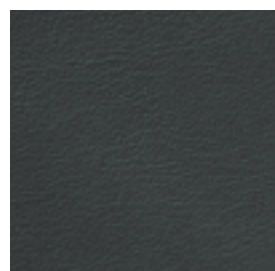

H35

Categoria H Metal 147



Finta pelle ignifuga - Fire retardant simil leather - Similcuir non-feu - Feuerhemmender Kunststoff - Imitacion de piel ignifuga



H80



H81



H82



H83

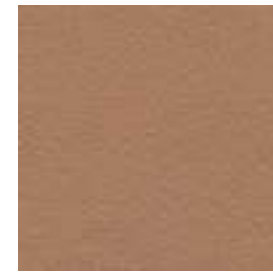

H84



H85



H86



H87



H88



H89

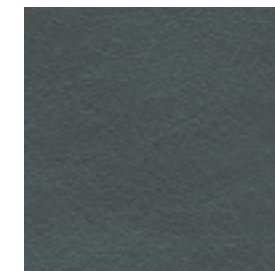

H90

Pedrali può offrire prodotti rivestiti con tessuto categoria H conformi alla Classificazione di reazione al Fuoco omologati CLASSE 1 IM ottenuta dal Ministero dell'Interno. La certificazione viene fornita se richiesto al momento dell'ordine.
Pedrali can offer products upholstered in fabric category H in compliance with fire reaction classification CLASSE 1 IM obtained by Ministry of the Interior. Certificate available if requested together with the order.

148 Categoria H



Tessuto ignifugo - Fire retardant fabric - Tissu non-feu - Feuerhemmende Stoffe - Tela ignifuga



H60*



H61*

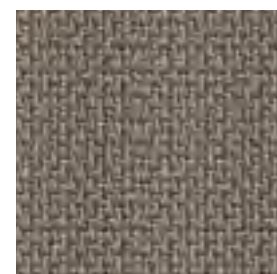

H62*



H63*

* Disponibile solo per art. 340/3 / Available for art. 340/3 only

Categoria H 149



Velluto ignifugo - Fire retardant velvet - Velours non-feu - Feuerhemmende velvetine - Terciopelo ignifugo

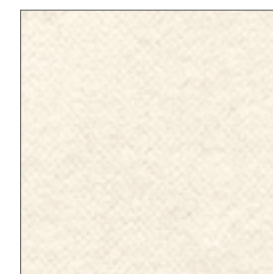

H40

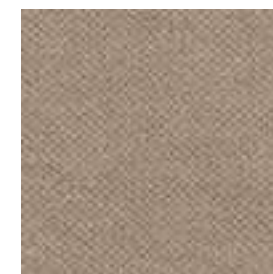

H44

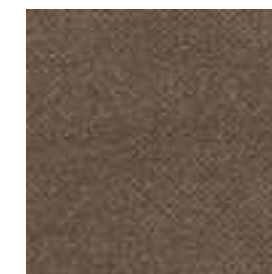

H45



H46



H48



H43



H49



H41



H53

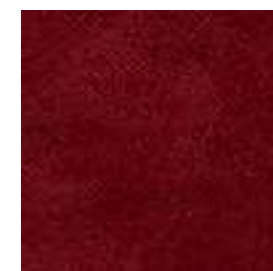

H42



H52



H47



H51



H50

150 Categoria P

Pelle mezzo fiore - Mid grain leather - Cuir mi-fleur - Vollleder - Piel media flor



PBI



PNE



PMA



PBE



PRO



PSA

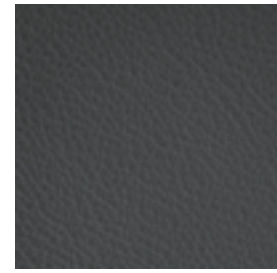

PGR



PTA



PGC

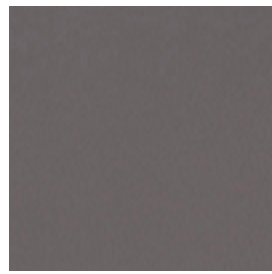

PGA



PBS



PCO

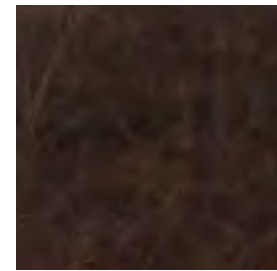

PMS



PVE

Pesi, dimensioni e colori sono indicativi. Pedrali si riserva la facoltà di apportare modifiche o migliorie senza alcun preavviso.
Weight, sizes and colours are approximate. Pedrali reserves the right to modify or upgrade the product without prior notice.

Tutte le collezioni Pedrali sono protette nel mondo dal diritto di proprietà industriale e da brevetti registrati.
All Pedrali collections are protected throughout the world by industrial design, patent and copyright registries.

Catologo Imbottiti | Edizione Febbraio 2015

Progetto grafico e art direction: **Borgo Creativo**
Photo: **Ezio Manciuca + Davide Cerati + Studio Odeon + Ottavio Tomasini + Katie Verkinderen**
Beppe Brancato

Styling: **Cristina Pasini**
Stampa: **Intese Grafiche**

Copyright Pedrali 2015

